



TEST REPORT

Applicant : Voltronic Power Technology Corp.
Address : No. 406, Xinhua 1st Road, Neihu District, Taipei, Taiwan, R.O.C.
Manufacturer : Voltronic Power Technology Corp.
Address : No. 406, Xinhua 1st Road, Neihu District, Taipei, Taiwan, R.O.C.
Product Name : MPPT SOLAR INVERTER
Trade Mark : N/A
Model No. : XPERT WP 8KW TWIN
Ratings : See the copy of marking plate on page 6
Standard : Safety of power converter for use in photovoltaic power systems
Part 1: General requirements
IEC 62109-1: 2010, EN 62109-1: 2010
Safety of power converter for use in photovoltaic power systems
Part 2: Particular requirements for inverters
IEC 62109-2: 2011, EN 62109-2: 2011
Date of Receiver : December 27, 2021
Date of Test : December 27, 2021 to January 11, 2022
Date of Issue : January 12, 2022
Test Report Form No : NTCS-IEC 62109-1-E
Test Result : Pass *

This Test Report is Issued Under the Authority of :

Compiled by



Leo Xia / Engineer

Approved by



Vic Wang/ Manager



*Remarks:

The results shown in this test report refer only to the sample(s) tested, this test report cannot be reproduced, except in full, without prior written permission of Shenzhen Nore Testing Center Co., Ltd. The report would be invalid without specific stamp of test institute and the signatures of compiler and approver.

Revision History of This Test Report

Report Number	Description	Issued Date
NTC2107613SV00	Initial Issue	2021-09-10
SZNTC2107613SV04	Update applicant, manufacturer, model, trademark, CDF and photo	2022-01-12

Summary of testing:

The product has been tested according to standard listed below:

- IEC 62109-1: 2010
- EN 62109-1: 2010
- IEC 62109-2: 2011
- EN 62109-2: 2011
- Others

This report is updated based on the report number NTC2107613SV00 issued by Shenzhen Nore Testing Center Co., Ltd. on September 10, 2021. Since the prototype has changed from single output to dual output, and added Relay board. This report re-evaluates the input test, temperature rise test and protective bonding impedance test.

General remarks:

"(see Attachment #)" refers to additional information appended to the report.

"(see appended table)" refers to a table appended to the report.

The tests results presented in this report relate only to the object tested.

This report shall not be reproduced except in full without the written approval of the testing laboratory.

List of test equipment must be kept on file and available for review.

Additional test data and/or information provided in the attachments to this report.

Throughout this report a comma / point is used as the decimal separator.

Factory 1: VOLTRONIC POWER TECHNOLOGY (SHENZHEN) CORP.

Address: 1-5F, Building 5 & 1F Building 7 & 1F Building 9, RunDongSheng Industrial Park, No.467, Section Xixiang, National Highway 107, LongTeng Community, Xixiang, Bao An District, Shenzhen, China

Factory 2: Zhongshan Voltronic Power Electronics Ltd

Address: No. 8 Shichong Rd Zhongshan Torch Hi-Tech Industrial Development Zone Zhongshan Guangdong 528437 CHINA

Test item particulars :	
Equipment mobility..... :	<input type="checkbox"/> movable <input type="checkbox"/> hand-held <input type="checkbox"/> stationary <input checked="" type="checkbox"/> fixed <input type="checkbox"/> transportable <input type="checkbox"/> for building-in
Connection to the mains..... :	<input type="checkbox"/> pluggable equipment <input type="checkbox"/> direct plug-in <input checked="" type="checkbox"/> permanent connection <input type="checkbox"/> for building-in
Environmental category..... :	<input type="checkbox"/> outdoor <input type="checkbox"/> indoor unconditional <input checked="" type="checkbox"/> indoor conditional
Over voltage category Mains..... :	<input type="checkbox"/> OVC I <input type="checkbox"/> OVC II <input checked="" type="checkbox"/> OVC III <input type="checkbox"/> OVC IV
Over voltage category PV..... :	<input type="checkbox"/> OVC I <input checked="" type="checkbox"/> OVC II <input type="checkbox"/> OVC III <input type="checkbox"/> OVC IV
Mains supply tolerance (%)..... :	±10%
Tested for power systems..... :	TN system
IT testing, phase-phase voltage (V)..... :	N/A
Class of equipment..... :	<input checked="" type="checkbox"/> Class I <input type="checkbox"/> Class II <input type="checkbox"/> Class III <input type="checkbox"/> Not classified
Mass of equipment (kg)..... :	Max. 32kg
Pollution degree..... :	PD 2
Operation ambient temperature..... :	-10°C~ 50°C
IP protection class..... :	IP65
Possible test case verdicts:	
- test case does not apply to the test object..... :	N/A (Not Applicable)
- test object does meet the requirement..... :	P (Pass)
- test object does not meet the requirement..... :	F (Fail)

General product information:

This is a multi-function inverter, combining functions of inverter, solar charger and battery charger to offer uninterruptible power support in a single package. The comprehensive LCD display offers user-configurable and easy-accessible button operations such as battery charging current, AC or solar charging priority, and acceptable input voltage based on different applications.

This inverter can power various appliances in home or office environment, including motor-type appliances such as tube light, fan, refrigerator and air conditioners.

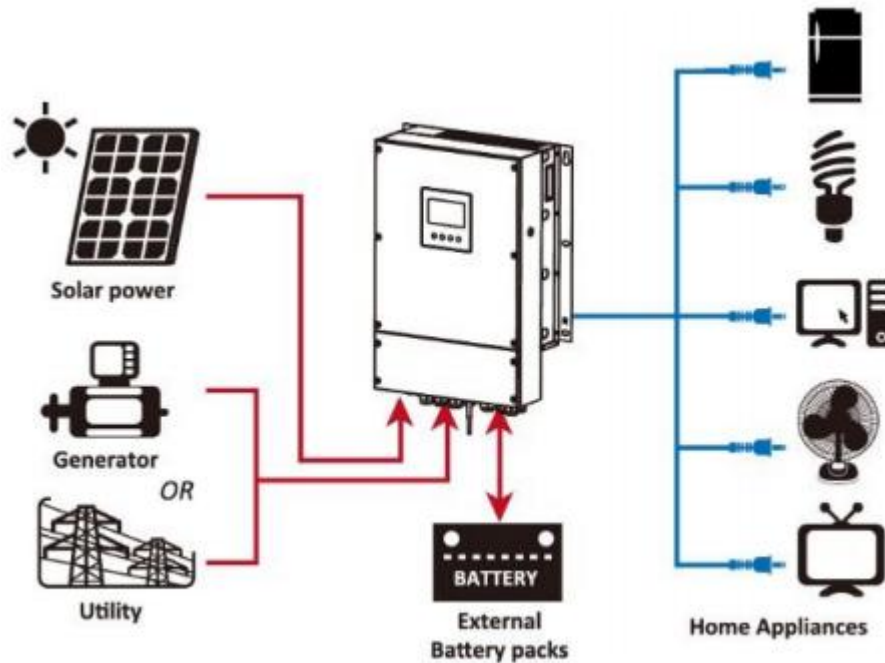
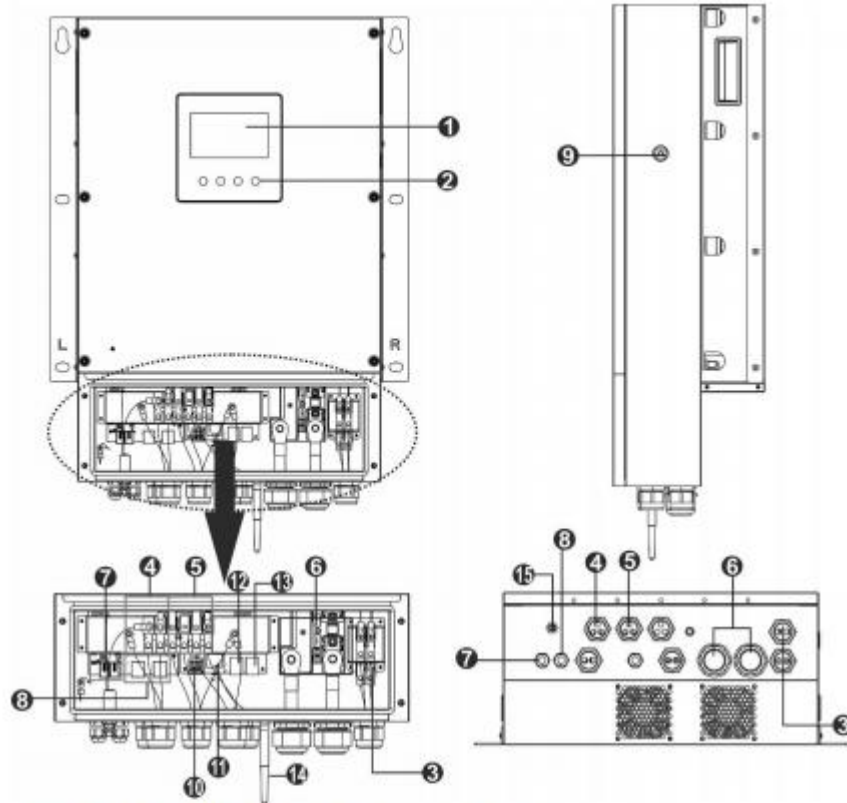

Figure 1 Basic hybrid PV System Overview

Product Overview:



NOTE: For parallel installation and operation, please check *Appendix I*.

1. LCD display
2. Touchable function keys
3. PV connectors
4. AC input connectors
5. AC output connectors (Load connection)
6. Battery connectors
7. Current sharing port
8. Parallel communication port
9. Power switch
10. Dry contact
11. USB port as USB communication port and USB function port
12. RS-232 communication port
13. BMS communication port: CAN, RS-485 or RS-232
14. WiFi antenna
15. Input circuit breaker



Copy of marking plate:



1. Rating label



Model No. : AXPERT WP 8KW TWIN	
Serial No. :  96342101100001	
PV INPUT	Nominal operating voltage 240Vdc
	Vmax PV 500Vdc
	MPPT voltage range 90-450Vdc
	Isc PV 18A *2
	Maximum PV Input Power 4000W *2
AC OUTPUT	Nominal operating voltage 230 Vac
	Nominal output current 34.8A
	Nominal operating frequency 50/60Hz
	Maximum power 8000W
	Maximum Power factor >0.99
AC INPUT	Nominal operating voltage 230Vac
	Maximum input current 60A
	Nominal operating frequency 50/60Hz
BATTERY	Battery rated voltage 48Vdc
	Maximum charging current 150A



Ambient temperature: -10~+50°C
 Enclosure: IP 65
 Protective class I





 5min

MADE IN CHINA
 VOLTRONIC POWER TECHNOLOGY (SHENZHEN) CORP.

IEC/EN 62109-1			
Clause	Requirement – Test	Result - Remark	Verdict
4	General testing requirements		P
4.1	General	Type test	P
4.2	General conditions for testing		P
4.2.1	Sequence of tests		P
4.2.2	Reference test conditions		P
4.2.2.1	Environmental conditions	Max. 50°C rated ambient Temperature tested.	P
	Unless otherwise specified, the following ambient environmental conditions shall exist in the test location: a) temperature of 15 °C to 40 °C b) a relative humidity of not more than 75 % and not less than 5% c) an air pressure of 75 kPa to 106 kPa. d) no frost, dew, percolating water, rain, solar radiation, etc.		P
4.2.2.2	State of equipment	Assembled for normal use	P
4.2.2.3	Position of equipment	Be installed in accordance with the manufacturer's instructions	P
4.2.2.4	Accessories		P
4.2.2.5	Covers and removable parts		P
4.2.2.6	Main supply	Rated and tolerances on rated supply conditions considered	P
4.2.2.7	Supply ports other than the mains	For PV input, the following additional requirements apply	P
4.2.2.7.1	Photovoltaic supply sources	PV source used	P
4.2.2.7.2	Battery inputs		P
4.2.2.8	Conditions of loading for output ports	Under the least favorable loading conditions	P
4.2.2.9	Earthing terminals	Be connected to earth	P
4.2.2.10	Controls		P
	Controls which the operator can adjust shall be set to any position except that		P
	a) mains selection devices shall be set to the correct value unless otherwise noted in this standard;		N/A
	b) Combinations of settings shall not be made if they are prohibited by the manufacturer's instructions provided with the equipment.		N/A
4.2.2.11	Available short circuit current	Considered the short circuit sourcing capability	P
4.3	Thermal testing		P
4.3.1	General		P

IEC/EN 62109-1			
Clause	Requirement – Test	Result - Remark	Verdict
4.3.2	Maximum temperature		P
4.3.2.1	General		P
	Materials and components shall be selected so that under the most severe rated operating conditions, the temperatures do not exceed the temperature limits.		P
	Conformity is verified by measuring temperatures under the conditions given in 4.2 for each rated operating condition or mode of the PCE that could affect the resulting temperatures.		P
	The temperature limits specified below are total temperature limits (not temperature rise limits).		P
	Tests of equipment rated for use in ambient temperatures up to 50°C may be conducted at any ambient temperature in the range given in 4.2.2.1, in which case the difference between the maximum rated ambient temperature and the test ambient is to be subtracted from or added to (as appropriate) the measured temperatures for comparison to the limits specified below.		N/A
	PCE rated for use in ambient temperatures more than 50°C shall be tested at the maximum rated ambient temperature +/- 5°C. the difference between the maximum rated ambient temperature and the test ambient is to be subtracted from or added to the measured temperatures for comparison to the limits specified.		P
	PCE with different output ratings or with automatic derating for different ambient temperatures shall be tested under as many conditions as are necessary to record worst-case temperatures, including at least the maximum ambient before derating, and the maximum ambient with derating.		N/A
	During thermal testing within NORMAL CONDITIONS protective devices shall not operate.		P
	Temperatures are to be measured by thermocouples, except that for coils the change of resistance method may be used.		P
	Limits: - for coils and their insulation systems, the temperature limits in Table 1 apply.		P
	- for other components the measured temperatures shall not exceed the lower of:		P
	- the applicable IEC component standards		P
	- the component or material's rated manufacturer's operating temperature		P

IEC/EN 62109-1			
Clause	Requirement – Test	Result - Remark	Verdict
	- if neither of the above exists, temperature limits are given in Table 2.		P
4.3.2.2	Touch temperatures		P
	The maximum temperature for accessible parts of the PCE shall be in compliance with table 3		P
	It is permitted that accessible parts that are required to get hot as part of their intended function (for example heatsinks) may have temperatures up to 100 °C, if the parts are marked with the hot surface marking of symbol 14 of Annex C. For products only for use in a closed electrical operating area the 100 °C limit does not apply.		P
4.3.2.3	Temperature limits for mounting surfaces		P
	In order to protect against long-term degradation of building materials, surfaces of the PCE that will be in contact with the mounting surface shall not exceed a maximum total temperature of 90 °C.		P
4.4	Testing in single fault condition		P
4.4.1	General		P
	Testing in single fault conditions is done to determine that no hazards result from reasonably expected fault conditions that may arise in normal service or from reasonably expected misuse.		P
	Fault testing shall be done unless it can be conclusively demonstrated that no hazards could arise from a particular fault condition, or unless alternative methods of checking conformity are specified in this standard in place of fault testing.		P
4.4.2	Test conditions and duration for testing under fault conditions		P
4.4.2.1	General		P
	The equipment shall be operated under the combination of conditions in 4.2, which is least favourable for the particular fault test being performed.		P
	Fault conditions are to be applied only one at a time and shall be applied in turn in any convenient order. Multiple simultaneous faults shall not be applied, but a subsequent fault may arise as a consequence from an applied fault. Separate samples of the EUT may be used for each separate fault test applied, or the same sample may be used for many tests if damage from previous fault tests has been repaired or will not affect the results of further tests.		P
4.4.2.2	Duration of tests		P
	The equipment shall be operated until further		P

IEC/EN 62109-1			
Clause	Requirement – Test	Result - Remark	Verdict
	change as a result of the applied fault is unlikely, as determined by (for example) opening of a device that removes the influence of the fault, stabilization of temperatures, etc.		
	If a non-resettable, manual, or automatically resetting protective device or circuit operates in such a way as to interrupt or mitigate the fault condition, the test duration is as follows:		P
	- automatic reset devices or circuits: allow the protection to cycle on and off until no further change as a result of the applied fault is likely, until the ultimate result is obtained, or until temperatures stabilize		P
	- manual reset devices or circuits: three cycles, with the device or circuit reset as soon as possible after tripping		P
	- non-resettable devices or circuits: one cycle		P
4.4.3	Pass/fail criteria for testing under fault conditions		P
4.4.3.1	Protection against shock hazard		P
	Compliance with requirements for protection against electric shock is checked after the application of single faults as follows:		P
	a) by making measurements to check that no accessible DVC-A circuits have become shock hazardous using the steady state limits for DVC-A in Table 6 and the short-term limits of 7.3.2.3, and that such circuits remain separated from live parts at voltages greater than DVC A with at least basic insulation. Compliance is checked by the test of 7.5.2 (without humidity preconditioning) for basic insulation; and		P
	b) by performing a dielectric strength test as per 7.5.2 (without humidity preconditioning) in the following cases:		P
	i) on reinforced or double Insulation, using the test level for Basic insulation, and		P
	ii) on basic insulation in Protective Class I equipment, using the test level for Basic insulation, unless it can be determined that the fault did not result in any damage to the protective earthing conductor or terminal, or to protective bonding means; and		P
	c) by inspection to ensure a fuse connected between the protective earthing terminal and the protective earthing conductor in the test setup has not opened; the fuse shall be rated 3A non-time-delay (for equipment rated for use on circuits protected by overcurrent protection rated 30A or less) or 30A to 35A non-time-delay (for equipment rated for use on circuits protected by		P

IEC/EN 62109-1			
Clause	Requirement – Test	Result - Remark	Verdict
	overcurrent protection rated more than 30A); the enclosure is not to be contacting earth in any other location during the testing; and		
	d) by inspection of the enclosure to ensure that no damage has resulted that allows access to parts that are hazardous live.		P
4.4.3.2	Protection against the spread of fire		P
	Compliance with requirements for protection against the spread of fire is checked by placing the equipment on white tissue-paper covering a soft-wood surface and covering the equipment with cheesecloth or surgical cotton during the fault test- ing. As an alternative, the cheesecloth or surgical cotton may be placed only over the openings of large equipment.		P
	There shall be no emission of molten metal, burning insulation, or flaming or glowing particles from the fire enclosure, and there shall be no charring, glowing, or flaming of the tissue paper, cheesecloth, or glowing or flaming of surgical cotton.		P
4.4.3.3	Protection against other hazards		P
	Conformity with requirements for protection against other HAZARDS after application of the fault tests is checked as specified elsewhere in this standard.		P
4.4.3.4	Protection against parts expulsion hazards		P
	Failure of any component within the PCE shall not release parts outside the PCE enclosure with sufficient energy to lead to a hazard, for example, ex- pulsion of material into an area occupied by per- sonnel.		P
4.4.4	Single Fault conditions to be applied		P
4.4.4.1	Component fault tests		P
	The following faults are simulated:		P
	a) Short circuit or open circuit of relevant components		P
	b) Short circuit or open circuit of any components or insulation where failure could adversely affect supplementary insulation or reinforced insulation.		P
	c) In addition, where required by Method 2 of 9.1.1, components that could result in a fire hazard are to be overloaded unless they comply with the requirements of 9.1.3		P
4.4.4.2	Equipment or parts for short-term or intermittent operation	Not for short-term or Intermittent operation	N/A
	Components such as motors, relays, other electromagnetic devices and heaters, which are		N/A

IEC/EN 62109-1			
Clause	Requirement – Test	Result - Remark	Verdict
	nor- mally operated only intermittently, shall be operated continuously if continuous operation could occur in a single fault conditions.		
4.4.4.3	Motors	For fan motor	P
	Motors shall be stopped while fully energized or prevented from starting, whichever is less favourable.		P
4.4.4.4	Transformer short circuit tests		P
	The output windings of transformers shall be short- circuited one at a time. A transformer damaged during one test may be repaired or replaced before the next test.		P
4.4.4.5	Output short circuit		P
	Testing is required to be performed on all combinations of terminals for the port under consideration, two at a time, including neutral and earth terminals, and one test with all current-carrying terminals of the port shorted together at once.	(1) Line and Neutral	P
	the short-circuit currents are to be recorded and if they exceed the maximum rated current of the circuit, the maximum measured current shall be provided in the installation manual for the purpose of coordination of overcurrent protection of the exter- nal circuit conductors.		N/A
4.4.4.6	Backfeed current test	Considered	P
	For equipment intended to be connected simultaneously to more than one source of supply, each input of the PCE shall be tested one at a time, to determine if hazardous conditions can result from current from one source of supply flowing into the wiring for another source under fault conditions.	Considered	P
	With the PCE operating under normal conditions, a short circuit shall be applied at the field wiring terminals of the circuit under consideration, with all intended other sources connected to the PCE through the over current protective devices (if any) intended to be present in the installation.	Considered	P
	the short-circuit currents are to be recorded and if they exceed the maximum rated current for the port, the maximum measured current shall be provided in the installation manual for the purpose of coordination of overcurrent protection of the exter- nal circuit conductors		N/A
4.4.4.7	Output overload		P
	Each output of the PCE, and each section of a tapped output, shall be overloaded in turn, one at a time. The other windings are loaded or not loaded, whichever load condition of normal use is		P

IEC/EN 62109-1			
Clause	Requirement – Test	Result - Remark	Verdict
	less favorable. Overloading is carried out by connecting a variable resistor across the winding. The resistor is adjusted as quickly as possible and readjusted, if necessary, after 1 min to maintain the applicable overload. No further readjustments are then permitted.		
	If overcurrent protection is provided by a current-sensitive device or circuit, the overload test current is the maximum current which the overcurrent protection device is just capable of passing for 1 h. If this value cannot be derived from the specification, it is to be established by test. Before the test, the device is made inoperative or replaced by a link with negligible impedance.		P
	For equipment in which the output voltage is designed to collapse when a specified overload current is reached, the overload is slowly increased to the point of maximum output power before the point which causes the output voltage to collapse.		N/A
	In all other cases, the loading is the maximum power output obtainable from the output.		N/A
4.4.4.8	Cooling system failure		P
4.4.4.9	Heating devices	No heating devices	N/A
	In equipment incorporating heating devices, the following faults shall be applied one at a time: a) timers which limit the heating period shall be overridden to energize the heating circuit continuously; b) temperature control devices or circuits shall have single fault conditions applied such that control over the heater is lost. Over-temperature protection devices meeting the requirements of 14.3 are left operational during the test.		N/A
4.4.4.10	Safety interlock	No safety interlock	N/A
4.4.4.11	Reverse d.c. connections	Prevent reversal	P
4.4.4.12	Voltage selector mismatch	No voltage selector	N/A
4.4.4.13	Mis-wiring with incorrect phase sequence or polarity		P
4.4.4.14	PWB short-circuit test		P
4.5	Humidity preconditioning		P
4.5.1	General		P
4.5.2	Conditions	48hours	P
	Relative humidity (%), temperature (°C)	93%RH, 40°C	P
4.6	Voltage Backfeed protection		P
4.6.1	Backfeed tests under normal conditions		P

IEC/EN 62109-1			
Clause	Requirement – Test	Result - Remark	Verdict
4.6.2	Backfeed tests under single-fault conditions		P
4.6.3	Compliance with backfeed tests		P
	The PCE is compliant with the requirements if during the tests in 4.6.1 and 4.6.2 no hazardous voltage or energy is present on the PCE terminals for the source under test. Measurements are taken 15 s or 1 s after the source is de-energized or disconnected, as follows:		P
	- 15 s for sources that are connected by fixed wiring	Permanently connected	P
	- 1 s for sources that are cord-connected or use connectors that can be opened without the use of a tool		N/A
4.7	Electrical ratings tests		P
4.7.1	Input ratings	(see appended table)	P
4.7.1.1	Measurement requirements for DC input ports		P
4.7.2	Output ratings		P
5	MARKING AND DOCUMENTATION		P
5.1	Marking		P
5.1.1	General		P
	Equipment shall bear markings as specified in 5.1 and 5.2	Label are marked on PCE and graphic symbol is explained in user manual	P
	Graphic symbols may be used and shall be in accordance with Annex C or IEC 60417 as applicable.		P
	Graphic symbols shall be explained in the documentation provided with the PCE.		P
5.1.2	Durability of markings		P
	Markings required by this clause to be located on the PCE shall remain clear and legible under conditions of NORMAL USE and resist the effects of cleaning agents specified by the manufacturer	The label was subjected to the permanence of marking test. The label was rubbed with cloth soaked with water for 30 sec. And then again for 30 sec. with the cloth soaked with isopropyl alcohol. After this test there was no damage to the label. The marking on the label did not fade. There was no curling or lifting of the label edge.	P
5.1.3	Identification		P
	The equipment shall, as a minimum, be permanently marked with:		P

IEC/EN 62109-1			
Clause	Requirement – Test	Result - Remark	Verdict
	a) the name or trade mark of the manufacturer or supplier		P
	b) model number, name or other means to identify the equipment		P
	c) a serial number, code or other marking allowing identification of manufacturing location and the manufacturing batch or date within a three month time period.		P
5.1.4	Equipment ratings		P
	Unless otherwise specified in another part of IEC 62109, the following ratings, as applicable shall be marked on the equipment:	See together with EN 62109-2 for detail	P
	- input voltage, type of voltage (a.c. or d.c.), frequency, and max. continuous current for each input	Refer to the marking label	P
	- output voltage, type of voltage (a.c. or d.c.), frequency, max. continuous current, and for a.c. outputs, either the power or power factor for each output	Refer to the marking label	P
	- the ingress protection (IP) rating as in 6.3 below	Refer to the marking label	P
5.1.5	Fuse identification		P
	Marking shall be located adjacent to each fuse or fuseholder, or on the fuseholder, or in another location provided that it is obvious to which fuse the marking applies, giving the fuse current rating and where fuses of different voltage rating value could be fitted, the fuse voltage rating.		P
	Where fuses with special fusing characteristics such as time delay or breaking capacity are necessary, the type shall also be indicated		P
	For fuses not located in operator access areas and for soldered-in fuses located in operator access areas, it is permitted to provide an unambiguous cross-reference (for example, F1, F2, etc.) to the servicing instructions which shall contain the relevant information.		P
5.1.6	Terminals, Connections, and Controls		P
	If necessary for safety, an indication shall be given of the purpose of terminals, connectors, controls, and indicators, and their interchangeable positions, including any connections for coolant fluids such as water and drainage. The symbols in Annex C may be used, and where there is insufficient space, symbol 9 of Annex C may be used.		P
	Push-buttons and actuators of emergency stop devices, and indicator lamps used only to indicate a warning of danger or the need for urgent action	LCD display and LED indicator	P

IEC/EN 62109-1			
Clause	Requirement – Test	Result - Remark	Verdict
	shall be coloured red.		
	A multiple-voltage unit shall be marked to indicate the particular voltage for which it is set when shipped from the factory. The marking is allowed to be in the form of a paper tag or any other nonpermanent material.		N/A
	A unit with d.c. terminals shall be plainly marked indicating the polarity of the connections, with:	The “+” and “-” marking were provided adjacent to the PV and battery input terminals	P
	- the sign “+” for positive and “-” for negative; or		P
	- a pictorial representation illustrating the proper polarity where the correct polarity can be unambiguously determined from the representation	Not provided	N/A
5.1.6.1	Protective Conductor Terminals		P
	The means of connection for the protective earthing conductor shall be marked with:		P
	symbol 7 of Annex C; or		P
	the letters “PE”; or		P
	the colour coding green-yellow.		P
5.1.7	Switches and circuit-breakers		N/A
	The on and off-positions of switches and circuits breakers shall be clearly marked. If a push-button switch is used as the power switch, symbols 10 and 16 of Annex C may be used to indicate the on-position, or symbols 11 and 17 to indicate the off-position, with the pair of symbols (10 and 16, or 11 and 17) close together.	“ON” and “OFF”	N/A
5.1.8	Class II Equipment	Class I apparatus	N/A
	Equipment using Class II protective means throughout shall be marked with symbol 12 of Annex C. Equipment which is only partially protected by DOUBLE INSULATION or REINFORCED INSULATION shall not bear symbol 12 of Table Annex C.		N/A
	Where such equipment has provision for the connection of an earthing conductor for functional reasons (see 7.3.6.4) it shall be marked with symbol 6 of Annex C		N/A
5.1.9	Terminal boxes for External Connections	No such parts	N/A
	Where required by note 1 of Table 2 as a result of high temperatures of terminals or parts in the wiring compartment, there shall be a marking, visible beside the terminal before connection, of either:		N/A
	a) the minimum temperature rating and size of the cable to be connected to the TERMINALS; or		N/A

IEC/EN 62109-1			
Clause	Requirement – Test	Result - Remark	Verdict
	b) a marking to warn the installer to consult the installation instruction. Symbol 9 of Table D-1 is an acceptable marking		N/A
5.2	Warning markings		P
5.2.1	Visibility and legibility requirements for warning markings		P
	Warning markings shall be legible, and shall have minimum dimensions as follows:		P
	- Printed symbols shall be at least 2,75 mm high		P
	- Printed text characters shall be at least 1.5 mm high and shall contrast in colour with the background		P
	- Symbols or text that are moulded, stamped or engraved in a material shall have a character height of at least 2,0 mm, and if not contrasting in colour from the background, shall have a depth or raised height of at least 0,5 mm.		P
	If it is necessary to refer to the instruction manual to preserve the protection afforded by the equipment, the equipment shall be marked with symbol 9 of Annex C	The manual provides necessary information for Warning marking	P
	Symbol 9 of Annex C is not required to be used adjacent to symbols that are explained in the manual		P
5.2.2	Content for warning markings		P
5.2.2.1	Ungrounded heatsinks and similar parts		N/A
	An ungrounded heat sink or other part that may be mistaken for a grounded part and involves a risk of electric shock in accordance with 7.3 shall be marked with symbol 13 of Annex C, or equivalent. The marking may be on or adjacent to the heatsink and shall be clearly visible when the PCE is disassembled to the extent that a risk of contact with the heatsink exists.		N/A
5.2.2.2	Hot Surfaces		N/A
	A part of the PCE that exceeds the temperature limits specified in 4.3.2 shall be marked with symbol 14 of Annex C or equivalent.		N/A
5.2.2.3	Coolant	Coolant is not used	N/A
	A unit containing coolant that exceeds 70 °C shall be legibly marked externally where readily visible after installation with symbol 15 of Annex C. The documentation shall provide a warning regarding the risk of burns from hot coolant, and either:		N/A
	statement that coolant system servicing is to be done only by SERVICE PERSONNEL, or		N/A
	instructions for safe venting, draining, or		N/A

IEC/EN 62109-1			
Clause	Requirement – Test	Result - Remark	Verdict
	otherwise working on the cooling system, if these operations can be performed without OPERATOR access to HAZARDS internal to the equipment		
5.2.2.4	Stored energy		P
	Where required by 7.3.9.2 or 7.4.2 the PCE shall be marked with Symbol 21 of Annex C and the time to discharge capacitors to safe voltage and energy levels shall accompany the symbol.		P
5.2.2.5	Motor guarding		N/A
	Where required by 8.2 a marking shall be provided where it is visible to service personnel before removal of a guard, warning of the hazard and giving instructions for safe servicing (for example disconnection of the source before removing the guard).		N/A
5.2.3	Sonic hazard markings and instructions	Hazardous noise is not produced	N/A
	If required by 10.2.1 a PCE shall:		N/A
	a) be marked to warn the operator of the sonic pressure hazard; or		N/A
	b) be provided with installation instructions that specify how the installer can ensure that the sound pressure level from equipment at its point of use after installation, will not reach a value, which could cause a hazard. These instructions shall include the measured sound pressure level, and shall identify readily available and practicable protective materials or measures which may be used.		N/A
5.2.4	Equipment with multiple sources of supply		P
	A PCE with connections for multiple energy sources shall be marked with symbol 13 of Annex C and the manual shall contain the information required in 5.3.4.		P
	The symbol shall be located on the outside of the unit or shall be prominently visible behind any cover giving access to hazardous parts.		P
5.2.5	Excessive touch current		P
	Where required by 7.3.6.3.7 the PCE shall be marked with symbol 15 of Annex C. See also 5.3.2 for information to be provided in the installation manual.	Warning symbol provided	P
5.3	Documentation		P
5.3.1	General		P
	The documentation provided with the PCE shall provide the information needed for the safe operation, installation, and (where applicable)		P

IEC/EN 62109-1			
Clause	Requirement – Test	Result - Remark	Verdict
	maintenance of the equipment. The documentation shall include the items required in 5.3.2 through 5.3.4, and the following:		
	a) explanations of equipment makings, including symbols used		P
	b) location and function of terminals and controls		P
	c) all ratings or specifications that are necessary to safely install and operate the PCE, including the following environmental ratings along with an explanation of their meaning and any resulting installation requirements:		P
	- ENVIRONMENTAL CATEGORY as per 6.1	IP65	P
	- WET LOCATIONS classification for the intended external environment as per 6.1	Not suitable for wet location	N/A
	- POLLUTION DEGREE classification for the intended external environment as per 6.2	PD2	P
	- INGRESS PROTECTION rating as per 6.3	IP65	P
	- Ambient temperature and relative humidity ratings	Max. +50°C and 95% R.H.	P
	- MAXIMUM altitude rating	2000m	P
	- OVERVOLTAGE CATEGORY assigned to each input and output port as per 7.3.7.1.2, accompanied by guidance regarding how to ensure that the installation complies with the required overvoltage categories;	OVC II (PV and battery circuits), OVC III (Mains)	P
	d) a warning that when the photovoltaic array is exposed to light, it supplies a d.c. voltage to the PCE		P
5.3.1.1	Language		P
	Instructions related to safety shall be in a language that is acceptable in the country where the equipment is to be installed.	In English	P
5.3.1.2	Format	In printed form	P
	In general, the documentation must be provided in printed form and is to be delivered with the equipment.		P
	For equipment which requires the use of a computer for both installation and operation, documentation may be provided in electronic format without accompanying printed format.		N/A
5.3.2	Information related to installation		P
	The documentation shall include installation and where applicable, specific commissioning instructions and, if necessary for safety, warnings against hazards which could arise during installation or commissioning of the equipment. The information provided shall include:		P

IEC/EN 62109-1			
Clause	Requirement – Test	Result - Remark	Verdict
	a) assembly, location, and mounting requirements;		P
	b) ratings and means of connection to each source of supply and any requirements related to wiring and external controls, colour coding of leads, disconnection means, or overcurrent protection needed, including instructions that the installation position shall not prevent access to the disconnection means;		P
	c) ratings and means of connection of any outputs from the PCE, and any requirements related to wiring and external controls, colour coding of leads, or overcurrent protection needed;		P
	d) explanation of the pin-out of connectors for external connections, unless the connector is used for a standard purpose (e.g. RS 232)		P
	e) ventilation requirements;		P
	f) requirements for special services, for example cooling liquid;		N/A
	g) instructions and information relating to sound pressure level if required by 10.2.1;		N/A
	h) where required by 14.8.1.3, instructions for the adequate ventilation of the room or location in which PCE containing vented or valve-regulated batteries is located, to prevent the accumulation of hazardous gases;		P
	i) tightening torque to be applied to wiring terminals;		P
	j) values of backfeed short-circuit currents available from the PCE on input and output conductors under fault conditions, if those currents exceeds the max. rated current of the circuit, as per 4.4.4.6;		N/A
	k) for each input to the PCE, the max value of short-circuit current available from the source, for which the PCE is designed; and		P
	l) compatibility with RCD and RCM;		N/A
	m) instructions for protective earthing, including the information required by 7.3.6.3.7 if a second protective earthing conductor is to be installed:	Warning symbol provided	P
	n) where required by 7.3.8, the installation instructions shall include the following or equivalent wording:		N/A
	“This product can cause a d.c. current in the external protective earthing conductor. Where a residual current-operated protective (RCD) or monitoring (RCM) device is used for protection in		N/A

IEC/EN 62109-1			
Clause	Requirement – Test	Result - Remark	Verdict
	a case of direct or indirect contact, only an RCD or RCM of Type B is allowed on the supply side of this product.“		
	o) for PCE intended to charge batteries, the battery nominal voltage rating, size, and type		P
	p) PV array configuration information, such as ratings, whether the array is to be grounded or floating, any external protection devices needed, etc.		P
5.3.3	Information related to operation		P
	Instructions for use shall include any operating instructions necessary to ensure safe operation, including the following, as applicable:		P
	- Instructions for adjustment of controls including the effects of adjustment;		P
	- Instructions for interconnection to accessories and other equipment, including indication of suitable accessories, detachable parts and any special materials;		P
	- Warnings regarding the risk of burns from surfaces permitted to exceed the temperature limits of 4.3.2 and required operator actions to reduce the risk; and		P
	- Instructions, that if the equipment is used in a manner not specified by the manufacturer, the protection provided by the equipment may be impaired.		P
5.3.4	Information related to maintenance		P
	Maintenance instructions shall include the following:		P
	- Intervals and instructions for any preventive maintenance that is required to maintain safety (for example air filter replacement or periodic re-tightening of terminals);		P
	- Instructions for accessing operator access areas, if any are present, including a warning not to enter other areas of the equipment;		P
	- Part numbers and instructions for obtaining any required operator replaceable parts;		P
	- Instructions for safe cleaning (if recommended)		P
	- Where there is more than one source of supply energizing the PCE, information shall be provided in the manual to indicate which disconnect device or devices are required to be operated in order to completely isolate the equipment.		P
5.3.4.1	Battery maintenance	No such parts	N/A

IEC/EN 62109-1			
Clause	Requirement – Test	Result - Remark	Verdict
	Where required by 14.8.5, the documentation shall include the applicable items from the following list of instructions regarding maintenance of batteries:		N/A
	- Servicing of batteries should be performed or supervised by personnel knowledgeable about batteries and the required precautions		N/A
	- When replacing batteries, replace with the same type and number of batteries or battery packs		N/A
	- General instructions regarding removal and installation of batteries		N/A
	- CAUTION: Do not dispose of batteries in a fire. The batteries may explode.		N/A
	- CAUTION: Do not open or damage batteries. Released electrolyte is harmful to the skin and eyes. It may be toxic.		N/A
	- CAUTION: A battery can present a risk of electrical shock and high short-circuit current. The following precautions should be observed when working on batteries:		N/A
	a) Remove watches, rings, or other metal objects.		N/A
	b) Use tools with insulated handles.		N/A
	c) Wear rubber gloves and boots.		N/A
	d) Do not lay tools or metal parts on top of batteries		N/A
	e) Disconnect charging source prior to connecting or disconnecting battery terminals		N/A
	f) Determine if battery is inadvertently grounded. If inadvertently grounded, remove source from ground. Contact with any part of a grounded battery can result in electrical shock. The likelihood of such shock can be reduced if such grounds are removed during installation and maintenance (applicable to equipment and remote battery supplies not having a grounded supply circuit).		N/A

6	Environmental requirements and conditions		P
	The manufacturer shall rate the PCE for the following environmental conditions:		P
	- ENVIRONMENTAL CATEGORY, as in 6.1 below	Indoor used	P
	- Suitability for WET LOCATIONS or not	Not	N/A
	- POLLUTION DEGREE rating in 6.2 below	PD2	P
	- INGRESS PROTECTION (IP) rating, as in 6.3 below	IP 65	P

IEC/EN 62109-1			
Clause	Requirement – Test	Result - Remark	Verdict
	- Ultraviolet (UV) exposure rating, as in 6.4 below		N/A
	- Ambient temperature and relative humidity ratings, as in 6.5 below	Max. 50°C, 95%R.H.	P
6.1	Environmental categories and minimum environmental conditions		P
6.1.1	Outdoor		N/A
6.1.2	Indoor, unconditioned		N/A
6.1.3	Indoor, conditioned	Dry, non-condensing	P
6.2	Pollution degree	PD2	P
6.3	Ingress Protection	IP65	P
6.4	UV exposure		N/A
6.5	Temperature and humidity	-10°C~+50°C, 5%~95%RH, Non-condensing	P

7	Protection against electric shock and energy hazards		P
7.1	General		P
7.2	Fault conditions	Compliance was checked by inspection, by analysis of normal and fault scenarios, and by the tests of 4.4.	P
7.3	Protection against electric shock		P
7.3.1	General	See 7.3.4 and 7.3.5 below	P
7.3.2	Decisive voltage classification		P
7.3.2.1	Use of decisive voltage class (DVC)	Considered the working voltage and applicable protective measures	P
7.3.2.2	Limits of DVC (according table 6)	DVC-A, DVC-C	P
7.3.2.3	Short-terms limits of accessible voltages under fault conditions		P
7.3.2.4	Requirements for protection (according table 7)	Functional, basic or protective separation	P
7.3.2.5	Connection to PELV and SELV circuits		P
7.3.2.6	Working voltage and DVC		P
7.3.2.6.1	General	Based on normal operation conditions at rated highest voltage	P
7.3.2.6.2	AC working voltage (see Figure 2)	(see appended table)	P
7.3.2.6.3	DC working voltage (see Figure 3)	(see appended table)	P
7.3.2.6.4	Pulsating working voltage (see Figure 4)		N/A
7.3.3	Protective separation		P
	Protective separation shall be achieved by:		P
	• double or reinforced insulation, or		P

IEC/EN 62109-1			
Clause	Requirement – Test	Result - Remark	Verdict
	<ul style="list-style-type: none"> protective screening, i.e. by a conductive screen connected to earth by protective bonding in the PCE, or connected to the protective earth conductor itself, whereby the screen is separated from live parts by at least basic insulation, or 		N/A
	<ul style="list-style-type: none"> protective impedance comprising limitation of current per 7.3.5.3 and of discharged energy per 7.3.5.4, or 		P
	<ul style="list-style-type: none"> limitation of voltage according to 7.3.5.4. 		P
	The protective separation shall be fully and effectively maintained under all conditions of intended use of the PCE		P
7.3.4	Protection against direct contact		P
7.3.4.1	General	Enclosure, barriers, insulation provided.	P
	Protection against direct contact is employed to prevent persons from touching live parts that do not meet the requirements of 7.3.5 and shall be provided by one or more of the measure given in 7.3.4.2 (enclosures and barriers) and 7.3.4.3 (insulation).		P
	Open type sub-assemblies and devices do not require protective measures against direct contact but the instruction provided with the equipment must indicate that such measures must be provided in the end equipment or in the installation.		P
	Product intended for installation in CLOSED ELECTRICAL OPERATING AREAS, (see 3.9) need not have protective measures against direct contact, except as required by 7.3.4.2.4.	Had to be evaluated in the final system	P
7.3.4.2	Protection by means of enclosures and barriers		P
	The following requirements apply where protection against contact with live parts is provided by enclosures or barriers, not by insulation in accordance with 7.3.4.3.		P
7.3.4.2.1	General		P
	Parts of enclosures and barriers that provide protection in accordance with these requirements shall not be removable without the use of a tool (see 7.3.4.2.3).	No removable enclosure	P
	Polymeric materials used to meet these requirements shall also meet the requirements of 13.6		N/A
7.3.4.2.2	Access probe criteria		P
	Protection is considered to be achieved when the separation between the test probes and live		P

IEC/EN 62109-1			
Clause	Requirement – Test	Result - Remark	Verdict
	parts, when tested as described below, is as follows:		
	a) decisive voltage classification A, (DVC A) - the probe may touch the live parts	The signal is considered as DVC A	P
	b) decisive voltage classification B, (DVC B) - the probe must not touch bare live parts	The DVC B circuit is not accessible by probe	P
	c) decisive voltage classification C, (DVC C) – the probe must have adequate clearance to live parts, based on the clearance for Basic insulation using the recurring peak working voltage involved,	The DVC C circuit is not accessible by probe	P
7.3.4.2.3	Access probe tests		P
	Compliance with 7.3.4.2.1 is checked by all of the following:		P
	a) Inspection; and		P
	b) Tests with the test finger (Figure D.1) and test pin (Figure D.2) of Annex D, the results of which shall comply with the requirements of 7.3.4.2.1 a), b), and c) as applicable. Probe tests are performed on openings in the enclosures after removal of parts that can be detached or opened by an operator without the use of a tool, including fuseholders, and with operator access doors and covers open. It is permitted to leave lamps in place for this test. Connectors that can be separated by an operator without use of a tool, shall also be tested during and after disconnection. Any movable parts are to be put in the most unfavorable position.		P
	The test finger and the test pin are applied as above, without appreciable force, in every possible position, except that floor-standing equipment having a mass exceeding 40 kg is not tilted.		P
	Equipment intended for building-in or rack mounting, or for incorporation in larger equipment, is tested with access to the equipment limited according to the method of mounting detailed in the installation instructions.		N/A
	c) Openings preventing the entry of the jointed test finger (Figure D.1 of Annex D) during test b) above, are further tested by means of straight unjointed test finger (Figure D.3 of Annex D), applied with a force of 30 N. If the unjointed finger enters, the test with the jointed finger is repeated except that the finger is applied using any necessary force up to 30 N.		P
	d) In addition to a) – c) above, top surfaces of		P

IEC/EN 62109-1			
Clause	Requirement – Test	Result - Remark	Verdict
	enclosure shall be tested with the IP3X probe of IEC 60529. The test probe shall not penetrate the top surface of the enclosure when probed from the vertical direction $\pm 5^\circ$ only.		
7.3.4.2.4	Service access areas	No enclosure is required to be opened when the PCE was energized during installation or maintenance	P
7.3.4.3	Protection by means of insulation of live parts	The earthed enclosure is with basic insulation form the live parts inside	N/A
	Where the requirements of 7.3.4.2 are not met, live parts shall be provided with insulation if:		N/A
	their working voltage is greater than the maximum limit of decisive voltage class A, or		N/A
	for a DVC A or B circuit, protective separation from adjacent circuit of DVC C is not provided (see note “2” under Table 7)		N/A
7.3.5	Protection in case of direct contact		P
7.3.5.1	General		P
	Protection in case of direct contact is required to ensure that contact with live parts does not produce a shock hazard.		P
	The protection against direct contact according to 7.3.4 is not required if the circuit contacted is separated from other circuits according to 7.3.2.3, and:		P
	- is of decisive voltage class A and complies with 7.3.5.2, or		P
	- is provided with protective impedance according to 7.3.5.3, or		P
	- is limited in voltage according to 7.3.5.4		P
	In addition to the measures as given in 7.3.5.2 to 7.3.5.4, it shall be ensured that in the event of error or polarity reversal of connectors no voltages that exceed DVC A can be connected into a circuit with protective separation. This applies for example to plug-in-sub-assemblies or other plug-in devices which can be plugged-in without the use of a tool (key) or which are accessible without the use of a tool.		P
	Conformity is checked by visual inspection and trial insertion.		P
7.3.5.2	Protection using decisive voltage class A	DVC-A	P
7.3.5.3	Protection by means of protective impedance		P
	Circuits and conductive parts do not require		P

IEC/EN 62109-1			
Clause	Requirement – Test	Result - Remark	Verdict
	protection against direct contact if any connection to circuits of DVC-B or DVC-C is through protective impedance, and the accessible circuit or part is otherwise provided with protective separation from circuits of DVC-B or DVC-C according 7.3.3.		
7.3.5.3.1	Limitation of current through protective impedance		P
	The current available through protective impedance to earth and between simultaneously accessible parts, measured at the accessible live parts, shall not exceed a value of 3,5 mA a.c. or 10 mA d.c. under normal and single-fault conditions.	Compliance was checked by inspection, by analysis of the relevant circuit diagrams, and by testing	P
7.3.5.3.2	Limitation of discharging energy through protective impedance		N/A
	The discharging energy available between simultaneously accessible parts protected by protective impedance shall not exceed the charging voltage and capacitance limits given in Table 9, which applies to both wet and dry locations, under normal and single fault conditions. Refer to figure 8.		N/A
7.3.5.4	Protection by means of limited voltages		N/A
	That portion of a circuit that has its voltage reduced to DVC-A by a voltage divider that complies with the following requirements, and that is otherwise provided with protective separation from circuits of DVC-B or DVC-C according to 7.3.3, does not require protection against direct contact.		N/A
	The voltage divider shall be designed so that under normal and single fault conditions, including faults in the voltage division circuit, the voltage across the output of the voltage divider does not exceed the limit for DVC-A.		N/A
	This type of protection shall not be used in case of protective class II or unearthed circuits, because it relies on protective earth being connected.		N/A
7.3.6	Protection against indirect contact		P
7.3.6.1	General		P
	Protection against indirect contact is required to prevent shock- hazardous current being accessible from conductive parts during an insulation failure. This protection shall comply with the requirements for protective class I (basic insulation plus protective earthing), class II (double or reinforced insulation) or class III (limitation of voltages)	Class I	P

IEC/EN 62109-1			
Clause	Requirement – Test	Result - Remark	Verdict
	That part of a PCE meets the requirements of 7.3.6.2 and 7.3.6.3 is defined as protective class I		P
	That part of a PCE meets the requirements of 7.3.6.4 is defined as protective class II.		N/A
	That part of PCE which meets the requirements of decisive voltage class A and in which no hazardous voltages are derived, is defined as protective class III. No shock hazard is present in such circuits.		N/A
	Where protection against indirect contact is dependent on means provided during installation, the installation instructions shall provide details of the required means and shall indicate the associated hazards.	The manual requires the PCE must be securely earthed	P
7.3.6.2	Insulation between live parts and accessible conductive parts		P
	Accessible conductive parts of equipment shall be separated from live parts by insulation meeting the requirements of Table 7 or by clearances as specified in 7.3.7.4 and creepages as specified in 7.3.7.5	Compliance was checked measurement of clearances, creepage distances and/or solid insulation.	P
7.3.6.3	Protective class I – Protective bonding and earthing		P
7.3.6.3.1	General		P
	Equipment of protective class I shall be provided with protective earthing, and with protective bonding to ensure electrical contact between accessible conductive parts and the means of connection for the external protective earthing conductor, except bonding is not required for:	Associated protective earthing and bonding conductor	P
	a) accessible conductive parts that are protected by one of the measures in 7.3.5.2 to 7.3.5.4, or		P
	b) accessible conductive parts are separated from live parts of DVC-B or -C using double or reinforced insulation.	Communication circuits are separated from live parts used double or reinforced insulation	P
7.3.6.3.2	Requirements for protective bonding		P
	Electrical contact with the means of connection of the external protective earthing conductor shall be achieved by one or more of the following means:		P
	a) through direct metallic contact;		P
	b) through other conductive parts which are not removed when the PCE or sub-units are used as intended ;		N/A
	c) through a dedicated protective bonding conductor;		N/A
	d) through other metallic components of the PCE		N/A

IEC/EN 62109-1			
Clause	Requirement – Test	Result - Remark	Verdict
	Where direct metallic contact is used and one or both of the parts involved is painted or coated, the paint or coating shall be removed in the area of contact, or reliably penetrated, to ensure metal to metal contact.	The metal enclosure is reliably Penetrated earthed	P
	For moving or removable parts, hinges or sliding contacts designed and maintained to have a low resistance are examples of acceptable means if they comply with the requirements of 7.3.6.3.3.	No such design	N/A
	Metal ducts of flexible or rigid construction and metallic sheaths shall not be used as protective bonding conductors, unless the device or material has been investigated as suitable for protective bonding purposes.	No such design	N/A
7.3.6.3.3	Rating of protective bonding		P
	Protective bonding shall withstand the highest thermal and dynamic stresses that can occur to the PCE item(s) concerned when they are subjected to a fault connecting live parts to accessible conductive parts. The protective bonding shall remain effective for as long as a fault to the accessible conductive parts persists or until an upstream protective device removes power from the part.	Compliance was checked as below	P
	Protective bonding shall meet following requirements:		P
	a) For PCE with an overcurrent protective device rating of 16 A or less, the impedance of the protective bonding means shall not exceed 0,1 Ω during or at the end of the test below.		N/A
	b) For PCE with an overcurrent protective device rating of more than 16 A, the voltage drop in the protective bonding test shall not exceed 2,5 V during or at the end of the test below.	<2.5V	P
	As alternative to a) and b) the protective bonding may designed according to the requirements for the external protective earthing conductor in 7.3.6.3.5, in which case no testing is required.		P
	The impedance of protective bonding means shall be checked by passing a test current through the bond for a period of time as specified below. The test current is based on the rating of the overcurrent protection for the equipment or part of the equipment under consideration, as follows:		P
	a) For pluggable equipment type A, the overcurrent protective device is that provided external to the equipment (for example, in the building wiring, in the mains plug or in an equipment rack);		N/A
	b) For pluggable equipment type B and fixed	Fixed equipment	P

IEC/EN 62109-1			
Clause	Requirement – Test	Result - Remark	Verdict
	equipment, the maximum rating of the overcurrent protective device specified in the equipment installation instructions to be provided external to the equipment;		
	c) For a circuit or part of the equipment for which an overcurrent protective device is provided as part of the equipment, the rating of the provided overcurrent device.		N/A
	Voltages are measured from the protective earthing terminal to all parts whose protective bonding means are being considered. The impedance of the protective earthing conductor is not included in the measurement. However, if the protective earthing conductor is supplied with the equipment, it is permitted to include the conductor in the test circuit but the measurement of the voltage drop is made only from the main protective earthing terminal to the accessible part required to be earthed.		P
	On equipment where the protective earth connection to a subassembly or to a separate unit is part of a cable that also supplies power to that subassembly or unit, the resistance of the protective bonding conductor in that cable is not included in the protective bond impedance measurements for the subassembly or separate unit, as shown in Figure 11. However, this option is only permitted if the cable is protected by a suitably rated protective device that takes into account the size of the conductor. Otherwise the impedance of the protective bonding conductor between the separate units is to be included, by measuring to the protective earthing terminal where the power source enters the first unit in the system, as shown in Figure 12.		N/A
7.3.6.3.3.1	Test current, duration, and acceptance criteria		P
	The test current, duration of the test and acceptance criteria are as follows:		P
	a) For PCE with an overcurrent protective device rating of 16 A or less, the test current is 200% of the overcurrent protective device rating, but not less than 32 A, applied for 120s. The impedance of the protective bonding means during and at the end of the test shall not exceed 0,1 Ω .		N/A
	b) For PCE with an overcurrent protective device rating of more than 16 A, the test current is 200% of the overcurrent protective device rating and the duration of the test is as shown in Table 10 below. The voltage drop in the protective bonding means, during and at the end of the test, shall not exceed 2,5 V.		P

IEC/EN 62109-1			
Clause	Requirement – Test	Result - Remark	Verdict
	c) During and after the test, there shall be no melting, loosening, or other damage that would impair the effectiveness of the protective bonding means.		P
	The test current is derived from an a.c or d.c supply source, the output of which is not earthed.		P
	As an alternative to Table 10, where the time-current characteristic of the overcurrent protective device that limits the fault current in the protective bonding means is known because the device is either provided in the equipment or fully specified in the installation instructions, the test duration may be based on that specific device's time-current characteristic,. The tests are conducted for a duration corresponding to the 200% current value on the time-current characteristic.		N/A
7.3.6.3.4	Protective bonding impedance (routine test)	Be carried out by the manufacturer	N/A
	If the continuity of the protective bonding is achieved at any point by a single means only (for example a single conductor or single fastener), or if the PCE is assembled at the installation location, then the impedance of the protective bonding shall also be tested as a routine test. The test shall be as in 7.3.6.3.3, except for the following:		N/A
	the test current may be reduced to any convenient value greater than 10 A sufficient to allow measurement or calculation of the impedance of the protective bonding means:		N/A
	the test duration may be reduced to no less than 2 s		N/A
	For equipment subject to the type test in 7.3.6.3.3.1a), the impedance during the routine test shall not exceed 0,1Ω.		N/A
	For equipment subject to the type test in 7.3.6.3.3.1b) the impedance during the routine test shall not exceed 2,5 V divided by the test current required by 7.3.6.3.3.1b).		N/A
7.3.6.3.5	External protective earthing conductor		P
	A protective earthing conductor shall be connected at all times when power is supplied to PCE of protective class I. Unless local wiring regulations state otherwise, the protective earthing conductor cross-sectional area shall be determined from Table 11 or by calculation according to IEC 60364-5-54.		P
	If the external protective earthing conductor is routed through a plug and socket or similar means of disconnection, it shall not be possible to		N/A

IEC/EN 62109-1			
Clause	Requirement – Test	Result - Remark	Verdict
	disconnect it unless power is simultaneously removed from the part to be protected.		
	The cross-sectional area of every external protective earthing conductor which does not form part of the supply cable or cable enclosure shall, in any case, be not less than:		P
	<ul style="list-style-type: none"> • 2,5 mm² if mechanical protection is provided; 		N/A
	<ul style="list-style-type: none"> • 4 mm² if mechanical protection is not provided. 		P
	For cord-connected equipment, provisions shall be made so that the external protective earthing conductor in the cord shall, in the case of failure of the strain-relief mechanism, be the last conductor to be interrupted.	Not cord-connected equipment.	N/A
7.3.6.3.6	Means of connection for the external protective earthing conductor		P
7.3.6.3.6.1	General		P
	<p>The means of connection for the external protective earthing conductor shall be located near the terminals for the respective live conductors. The means of connections shall be corrosion-resistant and shall be suitable for the connection of cables according to 7.3.6.3.5.</p> <p>The means of connection for the protective earthing conductor shall not be used as a part of the mechanical assembly of the equipment or for other connections.</p> <p>A separate means of connection shall be provided for each external protective earthing conductor.</p> <p>Connection and bonding points shall be so designed that their current-carrying capacity is not impaired by mechanical, chemical, or electrochemical influences. Where enclosures and/or conductors of aluminium or aluminium alloys are used, particular attention should be given to the problems of electrolytic corrosion.</p>	Terminal block provided	P
	The means of connection for the protective earthing conductor shall be permanently marked with:		P
	symbol 7 of Annex C; or		P
	the colour coding green-yellow		P
	Marking shall not be done on easily changeable parts such as screws.		P
7.3.6.3.7	Touch current in case of failure of the protective earthing conductor		P
	The requirements of this sub-clause shall be satisfied to maintain safety in case of damage to or disconnection of the protective earthing		P

IEC/EN 62109-1			
Clause	Requirement – Test	Result - Remark	Verdict
	conductor.		
	For pluggable equipment type A, the touch current measured in accordance with 7.5.4 shall not exceed 3,5 mA a.c. or mA d.c.		N/A
	For all other PCE, one or more of the following measure shall be applied, unless the touch current measured in accordance with 7.5.4 using the test network of IEC 60990 test figure 4 shall not exceed 3,5 mA a.c. or 10 mA d.c.	Compliance was checked by inspection, and by testing in accordance with 7.5.4.	P
	a) Permanently connected wiring, and:		P
	<ul style="list-style-type: none"> a cross-section of the protective earthing conductor of at least 10 mm² Cu or 16 mm² Al; or 		N/A
	<ul style="list-style-type: none"> automatic disconnection of the supply in case of discontinuity of the protective earthing conductor; or 		N/A
	<ul style="list-style-type: none"> provision of an additional terminal for a second protective earthing conductor of the same cross-sectional area as the original protective earthing conductor and installation instruction requiring a second protective earthing conductor to be installed or 		P
	b) Connection with an industrial connector according to IEC 60309 and a minimum protective earthing conductor cross-section of 2,5 mm ² as part of a multi-conductor power cable. Adequate strain relief shall be provided.		P
	In addition, the caution symbol 15 of Annex C shall be fixed to the product and the installation manual shall provide details of the protective earthing measures required in the installation as required in 5.3.2.	Warning symbol provided	P
	When it is intended and allowed to connect two or more PCEs in parallel using one common PE conductor, the above touch current requirements apply to the maximum number of the PCEs to be connected in parallel, unless one of the measures in a)		N/A
	or b) above is used. The maximum number of parallel PCEs is used in the testing and has to be stated in the installation manual.		N/A
7.3.6.4	Protective Class II – Double or Reinforced Insulation	Class I	N/A
	Equipment or parts of equipment designed for protective class II shall have insulation between live parts and accessible surfaces in accordance with 7.3.4.3. The following requirements also apply:		N/A
	Equipment designed to protective class II shall		N/A

IEC/EN 62109-1			
Clause	Requirement – Test	Result - Remark	Verdict
	not have means of connection for the external protective earthing conductor. However this does not apply if the external protective earthing conductor is passed through the equipment to equipment series-connected beyond it. In the latter event, the external protective earthing conductor and its means for connection shall be insulated with basic insulation from the accessible surface of the equipment and from circuits that employ protective separation, extra-low voltage, protective impedance and limited discharging energy, according to 7.3.5. This basic insulation shall correspond to the rated voltage of the series-connected equipment;		
	<ul style="list-style-type: none"> metal-encased equipment of protective class II may have provision on its enclosure for the connection of an equipotential bonding conductor; 		N/A
	<ul style="list-style-type: none"> equipment of protective class II may have provision for the connection of an earthing conductor for functional reasons or for damping of overvoltages; it shall, however, be insulated as though it is a live part; 		N/A
	<ul style="list-style-type: none"> equipment employing protective class II shall be marked according to 5.1.8. 		N/A
7.3.7	Insulation Including Clearance and Creepage Distance		P
7.3.7.1	General		P
	This subclause gives minimum requirements for insulation, based on the principles of IEC 60664.		P
	Manufacturing tolerances shall be taken into account during measurement of creepage, clearance, and insulation distance in the PCE.		P
	Insulation shall be selected after consideration of the following influences:		P
	<ul style="list-style-type: none"> pollution degree 	PD2	P
	<ul style="list-style-type: none"> overvoltage category 	Mains (OVC III)	P
	<ul style="list-style-type: none"> supply earthing system 	TN	P
	<ul style="list-style-type: none"> insulation voltage 		P
	<ul style="list-style-type: none"> location of insulation 	(see appended table)	P
	<ul style="list-style-type: none"> type of insulation 	(see appended table)	P
	Compliance of insulation, creepage distances, and clearance distances, shall be verified by measurement or visual inspection, and the tests of 7.5.	(see appended table)	P
7.3.7.1.1	Pollution degree	Determined according to 6.1 and 6.2.	P

IEC/EN 62109-1			
Clause	Requirement – Test	Result - Remark	Verdict
7.3.7.1.2	Overvoltage category and Impulse withstand voltage rating	PV (OVC II)	P
7.3.7.1.3	Supply earthing systems		P
	Three basic types of earthing system are described in IEC 60364-1. They are:		P
	<ul style="list-style-type: none"> TN system: has one point directly earthed, the accessible conductive parts of the installation being connected to that point by protective conductors. Three types of TN systems, TN-C, TN-S and TN-C-S, are defined according to the arrangement of the neutral and protective conductor. 		P
	<ul style="list-style-type: none"> TT system: has one point directly earthed, the accessible conductive parts of the installation being connected to earth electrodes electrically independent of the earth electrodes of the power system; 		N/A
	<ul style="list-style-type: none"> IT system: has all live parts isolated from earth or one point connected to earth through an impedance, the accessible conductive parts of the installation being earthed independently or collectively to the earthing system. 		N/A
7.3.7.1.4	Insulation voltages		P
	Table 12 makes use of the circuit system voltage and overvoltage category to define the impulse withstand voltage and the temporary overvoltage.	PV: OVC II, 2500V; Mains: OVC III, 4000V	P
7.3.7.2	Insulation between a circuit and its surroundings		P
7.3.7.2.1	General Basic, supplementary and reinforced insulation between a circuit and its surroundings shall be designed according to: Impulse voltage; temporary overvoltage; working voltage of the circuit;		P
7.3.7.2.2	Circuit connected directly to the mains Clearance and solid insulation between circuit connected directly to the mains and their surroundings shall be designed according to the impulse voltage, temporary overvoltage, or working voltage, whichever gives the most severe requirement		P
7.3.7.2.3	Circuit other than mains circuit Clearance and solid insulation between circuit other than the mains and their surroundings shall be designed according to impulse voltage and recurring peak voltage		P
7.3.7.2.4	Insulation between circuits		P

IEC/EN 62109-1			
Clause	Requirement – Test	Result - Remark	Verdict
	<p>a) For clearances and insulation, the requirements are determined by the circuit having the higher impulse voltage;</p> <p>b) For creepages, r.m.s. working voltage across the insulation determines the requirements.</p>		
7.3.7.3	<p>Functional insulation</p> <p>For parts or circuit in OVC I, functional insulation shall be designed according to the working voltage across the insulation</p> <p>For parts or circuit in OVC II, III, IV, functional insulation shall be designed according to the applicable impulse voltage as determined by 7.3.7.1.4</p>		P
7.3.7.4	Clearance distances	(see appended table)	P
7.3.7.4.1	<p>Determination</p> <p>Table 13 defines the minimum clearance distances required to provide functional, basic, or supplementary insulation</p>		P
	Clearance for use in altitudes above 2000 m shall be calculated with correction factor according to Table A.2 of IEC 60664-1		N/A
	For reinforced insulation, the value corresponding to the next higher impulse voltage, or 1.6 times the temporary overvoltage, or 1.6 times the working voltage shall be used, whichever results in the most severe requirement		P
7.3.7.4.2	<p>Electric field homogeneity</p> <p>For homogeneous electric field and impulse voltage is equal to or greater than 6000V for a circuit connected directly to the mains or 4000V within a circuit, the clearance may be reduced to the requirement by Table F.2 Case B of IEC 60664-1. In this case, impulse voltage test shall be performed on the clearance</p>		P
7.3.7.4.3	<p>Clearance to conductive enclosures</p> <p>Clearance shall be measured following the deformation test of 13.7 for conductive enclosures</p>		N/A
7.3.7.5	Creeage distances	(see appended table)	P
7.3.7.5.1	<p>General</p> <p>Creepage distances shall be large enough to prevent long-term degradation of the surface of solid insulators.</p> <p>For reinforced insulation, the value is doubled.</p> <p>If less than clearance, it shall be increased to that clearance</p>		P
7.3.7.5.2	<p>Voltage r.m.s. value of working voltage is used.</p> <p>Interpolation is permitted</p>		P

IEC/EN 62109-1			
Clause	Requirement – Test	Result - Remark	Verdict
7.3.7.5.3	Materials	If not otherwise specified, IIIa/IIIb was considered.	N/A
7.3.7.6	Coating		N/A
7.3.7.7	PWB spacings for functional insulation		N/A
7.3.7.8	Solid insulation		P
7.3.7.8.1	General Material for solid insulation shall be able to withstand mechanical, electrical, thermal and climatic stresses in normal use and ageing during the expected life- time.	Compliance was evaluated by test and inspection.	P
7.3.7.8.2	Requirements for electrical withstand capability of solid insulation		P
7.3.7.8.2.1	Basic and supplementary, reinforced, and double insulation. Solid insulation shall withstand the impulse voltage test 7.5.1 and voltage test 7.5.2.		P
	In addition, if recurring peak working voltage across the insulation is greater than 700 V and voltage stress on insulation is greater than 1kV/mm, double and reinforced insulation shall withstand the partial discharge test according to 7.5.3		N/A
7.3.7.8.2.2	Functional insulation		N/A
7.3.7.8.3	Thin sheet or tape material		P
7.3.7.8.3.1	General Insulation of thin sheet or tape less than 0,7 mm is subject to this requirement	Complied with the requirements for solid insulation in 7.3.7.8.1 and with 7.3.7.8.3.3	P
7.3.7.8.3.2	Material thickness not less than 0,2 mm		N/A
	Basic or supplementary insulation shall consist of at least one layer of material, and shall meet the impulse and a.c. or d.c. voltage test requirements of 7.3.7.8.2.1 for basic or supplementary insulation.		N/A
	Double insulation shall consist of at least two layers of material. Each layer shall meet the impulse and a.c. or d.c. voltage test requirements of 7.3.7.8.2.1 for basic insulation, and the partial discharge requirements of 7.3.7.8.2.1. The two or more layers together shall meet the impulse and a.c. or d.c. voltage test requirements of 7.3.7.8.2.1 for double insulation.		N/A
	Reinforced insulation shall consist of a single layer of material, which will meet the impulse, a.c. or d.c.voltage, and partial discharge test requirements 7.3.7.8.2.1 for reinforced insulation.		N/A
7.3.7.8.3.3	Material thickness less than 0,2 mm		P
	Basic or supplementary insulation shall consist of		P

IEC/EN 62109-1			
Clause	Requirement – Test	Result - Remark	Verdict
	at least one layer of material, and shall meet the impulse and a.c. or d.c. voltage test requirements of 7.3.7.8.2.1 for basic or supplementary insulation.		
	Double insulation shall consist of at least three layers of material. Each layer shall meet the impulse and a.c. or d.c. voltage test requirements of 7.3.7.8.2.1 for basic insulation any two layers together shall meet the impulse, a.c. or d.c. voltage, and partial discharge test requirements of 7.3.7.8.2.1 for double insulation.		P
	Reinforced insulation consisting of a single layer of material less than 0,2 mm thick is not permitted.		N/A
7.3.7.8.3.4	Compliance Component, sub-assembly, or material is checked by applicable tests 7.5.1 to 7.5.3 according to 7.3.7.8.		N/A
7.3.7.8.4	Printed wiring boards (PWBs)		P
7.3.7.8.4.1	General Insulation between conductor layers in double-sided single-layer PWBs, multi-layer PWBs and metal core PWBs, shall meet the requirements for solid insulation in 7.3.7.8.		P
	For the inner layers of multi-layer PWBs, the insulation between adjacent tracks on the same layer shall be treated as either:		P
	a creepage distance for pollution degree 1 and a clearance as in air (see Annex A, figure A.13); or		P
	as solid insulation, in which case it shall meet the requirements of 7.3.7.8.		P
7.3.7.8.4.2	Use of coating materials		N/A
7.3.7.8.5	Wound components		P
	Varnish or enamel insulation of wires shall not be used for basic, supplementary, double or reinforced insulation.		P
	Wound components shall meet the requirements of 7.3.7.8.1 and 7.3.7.8.2.		N/A
	The component itself shall pass the requirements given in 7.3.7.8.1 and 7.3.7.8.2. If the component has reinforced or double insulation, the voltage test in 7.5.2 shall be performed as a routine test.		N/A
7.3.7.8.6	Potting materials		N/A
	A potting material may be used to provide solid insulation or to act as a coating to protect against pollution. If used as solid insulation, it		N/A

IEC/EN 62109-1			
Clause	Requirement – Test	Result - Remark	Verdict
	shall comply with the requirements of 7.3.7.8.1 and 7.3.7.8.2. If used to protect against pollution, the requirements for Type 1 protection in 7.3.7.8.4.2 apply.		
7.3.7.9	Insulation requirements above 30 kHz		N/A
	Where voltages across insulation have fundamental frequencies greater than 30 kHz, further considerations apply. Requirements for this are provided in IEC 60664-4, and the more severe of these and the requirements of 7.3.7.1 to 7.3.7.8 shall be applied.		N/A
	Annex G contains flow-charts for the determination of clearance and creepage distances under these circumstances. For convenience, Tables 1 and 2 of IEC 60664-4 are also included in Annex G.		N/A
7.3.8	Residual Current-operated protective (RCD) or monitoring (RCM) device compatibility		N/A
	RCD and RCM are used to provide protection against insulation faults in some domestic and industrial installations, additional to that provided by the installed equipment.		N/A
7.3.9	Capacitor discharge		P
7.3.9.1	Operator access area	For permanent connected	N/A
	Equipment shall be so designed that there is no risk of electric shock in operator access areas from charge stored on capacitors after disconnection of the PCE.		N/A
7.3.9.2	Service access areas		P
	Capacitors located behind panels that are removable for servicing, installation, or disconnection shall present no risk of electric shock or energy hazard from charge stored on capacitors after disconnection of the PCE.		P
	Capacitors within a PCE shall be discharged to a voltage less than DVC A (see 7.3.2.2), or an energy level below the limits specified in 7.3.5.3.2, within 10 s after the removal of power from the PCE. If this requirement is not achievable for functional or other reasons, the warning symbol 21 of Annex C and an indication of the discharge time shall be placed in a clearly visible position on the enclosure, the capacitor protective barrier, or at a point close to the capacitor(s) concerned (depend- ing on the construction) (see 5.2.2.4).	After 8S, Capacitors within a PCE had be discharged to a voltage less than DVC A	P
	For energy storage devices (such as batteries or ultracapacitors) the intended function of which is to maintain charge even with the PCE off and disconnected from external sources, a barrier or		N/A

IEC/EN 62109-1			
Clause	Requirement – Test	Result - Remark	Verdict
	insulation shall be provided so that unintentional contact with hazardous live parts is prevented. The warning symbol 21 of Annex C shall be placed in a clearly visible position on or adjacent to the barrier or insulation, where it will be seen before removal of the barrier or insulation.		
7.4	Protection against energy hazards		P
7.4.1	Determination of hazardous energy level		P
	A hazardous energy level is considered to exist if		P
	a) The voltage is 2 V or more, and power available after 60 s exceeds 240 VA.		P
	b) The stored energy in a capacitor is at a voltage. U of 2 V or more, and the stored energy. E, calculated from the following equation, exceeds 20J: $E = 0,5 CU^2$		P
7.4.2	Operator Access Areas		P
	Equipment shall be so designed that there is no risk of energy hazard in operator access areas from accessible circuits.	DVC-A circuits with limited energy	P
7.4.3	Services Access Areas		P
	Energy storage devices located behind panels that are removable for servicing, installation or disconnection shall present no risk of electric energy hazard from charge stored after disconnection of the PCE.	Warning symbol provided	P
	Energy storage devices within a PCE shall be discharged to an energy level less than 20 J, as in 7.4.1, within 10 s after the removal of power from the PCE.		P
7.5	Electrical tests related to shock hazard		P
7.5.1	Impulse voltage test(type test)	(see appended table)	P
	The impulse voltage test is performed with a voltage having a 1.2/50 μ s waveform(see Figure 6 of IEC 60060-1) and is intended to simulate overvoltages induced by lightning or due to switching of equipment. See Table 15 for conditions of the impulse voltage test.	Compliance was checked via application of the impulse voltage test and is successfully passed. No puncture, flashover, or sparkover occurs.	P
	Tests on clearances smaller than required by Table 13(as allowed by 7.3.7.4.2) and on solid insulation are performed as type tests using appropriate voltages from Table 16.		P
	Tests on components and devices for protective separation are performed as atype test before they are assembled into the PCE, unless the test can be performed on the completed PCE without reducing the stress applied to the protective separation. Testing is performed using the impulse withstand voltages listed in column 3 or		N/A

IEC/EN 62109-1			
Clause	Requirement – Test	Result - Remark	Verdict
	column 5 of Table 16.		
7.5.2	Voltage test (dielectric strength test) (type test and routine test)	(see appended table)	P
7.5.2.1	Purpose of test		P
7.5.2.2	Value and type of test voltage		P
	The value of the test voltage are determined from column 2 or 3 of Table 17 or Table 18 depending upon whether the circuit under test is mains connected or not mains connected.		P
	The test voltage from column 2 is used for testing circuits with basic insulation.		P
	Between circuits with protective separation (double or reinforced insulation), the test voltage of column 3 shall be applied for type tests. For routine tests between circuits with protective separation the value from column 2 shall be applied, to prevent damage to the solid insulation due to causing partial discharge within the solid insulation.		P
	The values of column 3 shall apply to circuit with protective separation, and between circuits and accessible surfaces of PCE, which are non-conductive or conductive but not connected to the protective earthing conductor.		P
	The voltage test shall be performed with a sinusoidal voltage at 50 Hz or 60 Hz. If the circuit contains capacitors the test may be performed with a d.c. voltage of a voltage of a value equal to the peak value of the specified a.c. voltage.		P
7.5.2.3	Humidity preconditioning	For type test	P
	For type tests on PCE for which wet locations requirements apply, according to 6.1, the humidity preconditioning of 4.5 shall be performed immediately prior to the voltage test.		P
7.5.2.4	Performing the voltage test		P
7.5.2.5	Duration of the a.c. or d.c. voltage test		P
	The duration of the test shall be at least 60s for the type test and 1 s for the routine test. The test voltage may be applied with increasing and/or decreasing ramp voltage, and the ramp times are not specified, but regardless of the ramp time, the dwell time at full voltage shall be 60s and 1 s respectively for type and routine tests.	60s for type test	P
7.5.2.6	Verification of the a.c. or d.c. voltage test		P
	The test is successfully passed if no electrical breakdown occurs and there is no abnormal current flow during the test.		P
7.5.3	Partial discharge test (type test or sample test)		N/A

IEC/EN 62109-1			
Clause	Requirement – Test	Result - Remark	Verdict
	Where required by 7.3.7.8.2, the partial discharge test shall confirm that the solid insulation used within devices applied for protective separation of electrical circuits remains partial-discharge-free within the specified voltage range (see Table 19)		P
7.5.4	Touch current measurement (type test)	(see appended table)	P
	The touch current shall be measured if required by 7.3.6.3.7 and shall not be greater than 3.5 mA a.c. or 10 mA d.c. or special measures of protection as given in 7.3.6.3.7 are required.	7.2mA Warning symbol provided	P
	For type tests on PCE for which wet locations requirements apply according to 6.1, the humidity pre-conditioning of 4.5 shall be performed immediately prior to the touch current test.		N/A
7.5.5	Equipment with multiple sources of supply	Compliance was checked by evaluation of circuit diagrams and by the testing.	P

8	Protection against mechanical Hazards		P
8.1	General		P
	Operation shall not lead to a mechanical hazard in normal condition or single fault condition. Edges, projections, corners, openings, guards, handles and the like, that are accessible to the operator shall be smooth and rounded so as not to cause injury during normal use of the equipment.	Smooth and rounded	P
	Conformity is checked as specified in 8.2 to 8.6.		P
8.2	Moving parts		P
	Moving parts shall not be able to crush, cut or pierce parts of the body of an operator likely to contact them, nor severely pinch the operator's skin. Hazardous moving parts of equipment, that is moving parts which have the potential to cause injury, shall be so arranged, enclosed or guarded as to provide adequate protection against the risk of personal injury.		P
8.2.1	Protection of service persons		P
	Protection shall be provided such that unintentional contact with hazardous moving parts is unlikely during servicing operations. If a guard over a hazardous moving part may need to be removed for servicing, the marking of symbol 15 of Table D-1 shall be applied on or near the guard.		P
8.3	Stability		N/A
	Equipment and assemblies of equipment not secured to the building structure before operation	Fixed installation	N/A

IEC/EN 62109-1			
Clause	Requirement – Test	Result - Remark	Verdict
	shall be physically stable in normal use.		
8.4	Provisions for lifting and carrying		N/A
	If carrying handles or grips are fitted to, or supplied with, the equipment, they shall be capable of withstanding a force of four times the weight of the equipment.		N/A
	Equipment or parts having a mass of 18 kg or more shall be provided with a means for lifting and carrying or directions shall be given in the manufacturer's documentation.		N/A
8.5	Wall mounting		P
	Mounting brackets on equipment intended to be mounted on a wall or ceiling shall withstand a force of four times the weight of the equipment.	4 times the weight, applied for 1min	P
8.6	Expelled parts		N/A
	Equipment shall contain or limit the energy of parts that could cause a HAZARD if expelled in the event of a fault.		N/A

9	Protection Against Fire Hazards		P
9.1	Resistance to fire		P
	This subclause specifies requirements intended to reduce the risk of ignition and the spread of flame, both within the equipment and to the outside, by the appropriate use of materials and components and by suitable construction.	Achieved by the appropriate use of materials and components and by suitable construction.	P
9.1.1	Reducing the risk of ignition and spread of flame		P
	For equipment or a portion of equipment, there are two alternative methods of providing protection against ignition and spread of flame that could affect materials, wiring, wound components and electronic components such as integrated circuits, transistors, thyristors, diodes, resistors and capacitors.	Method 1	P
9.1.2	Conditions for a fire enclosure		P
	A fire enclosure is required for equipment or parts of equipment for which Method 2 is not fully applied and complied with.		P
9.1.2.1	Parts requiring a fire enclosure		P
	Except where Method 2 is used, or as permitted in 9.1.2.2, the following are considered to have a risk of ignition and, therefore, require a fire enclosure:		P
	- components in PRIMARY CIRCUITS		P
	- components in SECONDARY CIRCUITS supplied by power sources which exceed the limits for a LIMITED POWER SOURCE as specified in 9.2;		P

IEC/EN 62109-1			
Clause	Requirement – Test	Result - Remark	Verdict
	- components in SECONDARY CIRCUITS supplied by a LIMITED POWER SOURCE as specified in 9.2, but not mounted on a material of FLAMMABILITY CLASS V-1;		P
	- components within a power supply unit or assembly having a limited power output complying with the criteria for a LIMITED POWER SOURCE as specified in 9.2, including overcurrent protective devices, limiting impedances, regulating networks and wiring, up to the point where the LIMITED POWER SOURCE output criteria are met;		P
	- components having unenclosed arcing parts, such as open switch and relay contacts and commutators, in a circuit at HAZARDOUS VOLTAGE or at a HAZARDOUS ENERGY LEVEL; and		P
	- insulated wiring, except as permitted in 9.1.2.2.	PVC wire	P
9.1.2.2	Parts not requiring a fire enclosure		N/A
9.1.3	Materials requirements for protection against fire hazard		P
9.1.3.1	General		P
	Enclosure, components and other parts shall be so constructed, or shall make use of such materials, that the propagation of fire is limited.		P
9.1.3.2	Materials for fire enclosures	Metal	P
	If an enclosure material is not classified as specified below, a test may be performed on the final enclosure or part of the enclosure, in which case the material shall additionally be subjected to periodic sample testing.		N/A
9.1.3.3	Materials for components and other parts outside fire enclosures		N/A
	Except as otherwise noted below, materials for components and other parts (including MECHANICAL ENCLOSURES, ELECTRICAL ENCLOSURES and DECORATIVE PARTS); located outside FIRE ENCLOSURES, shall be of FLAMMABILITY CLASS HB.		N/A
9.1.3.4	Materials for components and other parts inside fire enclosures		P
9.1.3.5	Materials for air filter assemblies		N/A
9.1.4	Openings in fire enclosures	IP65	N/A
9.1.4.1	General		N/A
	For equipment that is intended to be used or installed in more than one orientation as specified in the product documentation, the following requirements apply in each orientation.		N/A

IEC/EN 62109-1			
Clause	Requirement – Test	Result - Remark	Verdict
	These requirements are in addition to those in the following sections:		N/A
	- 7.3.4, Protection against direct contact;		N/A
	- 7.4, Protection against energy hazards;		N/A
	- 13.5, Openings in enclosures		N/A
9.1.4.2	Side openings treated as bottom openings		N/A
9.1.4.3	Openings in the bottom of a fire enclosure		N/A
	The bottom of a FIRE ENCLOSURE or individual barriers, shall provide protection against emission of flaming or molten material under all internal parts, including partially enclosed components or assemblies, for which Method 2 of 9.1.1 has not been fully applied and complied with.		N/A
9.1.4.4	Equipment for use in a CLOSED ELECTRICAL OPERATING AREA		N/A
	The requirements of 9.1.4.3 do not apply to FIXED EQUIPMENT intended only for use in a CLOSED ELECTRICAL OPERATING AREA and to be mounted on a concrete floor or other non-combustible surface. Such equipment shall be marked as follows:		N/A
	WARNING: FIRE HAZARD SUITABLE FOR MOUNTING ON CONCRETE OR OTHER NON-COMBUSTIBLE SURFACE ONLY		N/A
9.1.4.5	Doors or covers in fire enclosures	No such doors	N/A
9.1.4.6	Additional requirements for openings in transportable equipment		N/A
9.2	Limited power source		P
9.2.1	General		P
9.2.2	Limited power source tests		P
9.3	Short-circuit and overcurrent protection		P
9.3.1	General		P
	The PCE shall not present a hazard, under short-circuit or overcurrent conditions at any port, including phase-to-phase, phase-to-earth and phase-to-neutral, and adequate information shall be provided to allow proper selection of external wiring and external protective devices.		P
9.3.2	Protection against short-circuits and overcurrents shall be provided for all input circuits, and for output circuits that do not comply with the requirements for limited power sources in 9.2, except for circuits in which no overcurrent hazard is presented by short-circuits and overloads.		P
9.3.3	Protective devices provided or specified shall have adequate breaking capacity to interrupt the		P

IEC/EN 62109-1			
Clause	Requirement – Test	Result - Remark	Verdict
	maximum short circuit current specified for the port to which they are connected. If protection that is provided integral to the PCE for an input port is not rated for the short-circuit current of the circuit in which it is used, the installation instructions shall specify that an upstream protective device, rated for the prospective short-circuit current of that port, shall be used to provide backup protection.		
10	Protection Against Sonic Pressure Hazards		N/A
10.1	General	No such hazards	N/A
	The equipment shall provide protection against the effect of sonic pressure. Conformity tests are carried out if the equipment is likely to cause such HAZARDS.		N/A
10.2	Sonic pressure and Sound level		N/A
10.2.1	Hazardous Noise Levels		N/A
11	Protection Against Liquid Hazards		N/A
11.1	Liquid Containment, Pressure and Leakage	No such hazards	N/A
	The liquid containment system components shall be compatible with the liquid to be used.		N/A
	There shall be no leakage of liquid onto live parts as a result of:		N/A
	Normal operation, including condensation;		N/A
	Servicing of the equipment; or		N/A
	Inadvertent loosening or detachment of hoses or other cooling system parts over time.		N/A
11.2	Fluid pressure and leakage		N/A
11.2.1	Maximum pressure		N/A
11.2.2	Leakage from parts		N/A
11.2.3	Overpressure safety device		N/A
11.3	Oil and grease		N/A
12	Chemical Hazards		N/A
12.1	General	No such hazards	N/A
13	Physical Requirements		P
13.1	Handles and manual controls		N/A

IEC/EN 62109-1			
Clause	Requirement – Test	Result - Remark	Verdict
	Handles, knobs, grips, levers and the like shall be reliably fixed so that they will not work loose in normal use, if this might result in a hazard. Sealing compounds and the like, other than selfhardening resins, shall not be used to prevent loosening. If handles, knobs and the like are used to indicate the position of switches or similar components, it shall not be possible to fix them in a wrong position if this might result in hazard.		N/A
13.1.1	Adjustable controls		N/A
13.2	Securing of parts	Compliance was checked by inspection, by measurement of clearance and creepage distances, and by manual test.	P
13.3	Provisions for external connections		P
13.3.1	General	Compliance is checked by inspection, and by applying the requirements of Clause 7, Clause 9 and the other applicable requirements	P
13.3.2	Connection to an a.c. Mains supply		P
13.3.2.1	General		P
	For safe and reliable connection to a MAINS supply, equipment shall be provided with one of the following:		P
	- terminals or leads or a non-detachable power supply cord for permanent connection to the supply; or	Terminal block for permanent connection	P
	- a non-detachable power supply cord for connection to the supply by means of a plug		N/A
	- an appliance inlet for connection of a detachable power supply cord; or		N/A
	- a mains plug that is part of direct plug-in equipment as in 13.3.8		N/A
13.3.2.2	Permanently connected equipment		P
13.3.2.3	Appliance inlets		N/A
13.3.2.4	Power supply cord		N/A
13.3.2.5	Cord anchorages and strain relief		N/A
	For equipment with a non-detachable power supply cord, a cord anchorage shall be supplied such that:		N/A
	- the connecting points of the cord conductors are relieved from strain; and		N/A
	- the outer covering of the cord is protected from abrasion.		N/A

IEC/EN 62109-1			
Clause	Requirement – Test	Result - Remark	Verdict
13.3.2.6	Protection against mechanical damage	Not be exposed to sharp points or cutting edges within or on the surface	P
13.3.3	Wiring terminals for connection of external conductors		P
13.3.3.1	Wiring terminals	By means of screws	P
13.3.3.2	Screw terminals	Have thread conforming to ISO 262 or ISO 262	P
13.3.3.3	Wiring terminal sizes	Accommodate the conductors specified in the installation documentation	P
13.3.3.4	Wiring terminal design	Clamp the conductor between metal surfaces with sufficient contact pressure and without damage to the conductor.	P
13.3.3.5	Grouping of wiring terminals	Be located in proximity to each other	P
13.3.3.6	Stranded wire	No likelihood of accidental contact between such a strand and other parts if a shock, energy, or fire hazard could result.	P
13.3.4	Supply wiring space	Allow the conductors to be introduced and connected easily	P
13.3.5	Wire bending space for wires 10 mm ² and greater	Compliance with the requirement of minimum bending space, terminal to obstruction	P
13.3.6	Disconnection from supply sources	Instructed in the installation instructions	P
13.3.7	Connectors, plugs and sockets	Compliance was checked by inspection, and by a test of connector misalignment or reverse polarity.	P
13.3.8	Direct plug-in equipment	Not direct plug-in equipment	N/A
13.4	Internal wiring and connections		P
13.4.1	General	The insulation, conductors and routing of all wires of the equipment was suitable for the electrical, mechanical, thermal and environmental conditions of use.	P
13.4.2	Routing	Wires were routed away from sharp edges, screw threads, burrs, fins, moving parts, drawers, and similar parts, which could abrade the wire insulation.	P

IEC/EN 62109-1			
Clause	Requirement – Test	Result - Remark	Verdict
13.4.3	Colour coding	Only color of yellow and green for protective and bonding conductor	P
13.4.4	Splices and connections	Electrical connections were soldered, welded, crimped, or otherwise securely connected	P
13.4.5	Interconnections between parts of the PCE		P
13.5	Openings in enclosures		P
13.5.1	Top and side openings		P
	Openings in the top and sides of ENCLOSURES shall be so located or constructed that it is unlikely that objects will enter the openings and create hazards by contacting bare conductive parts.	(see appended table)	P
13.6	Polymeric Materials		P
13.6.1	General		P
13.6.1.1	Thermal index or capability		P
13.6.2	Polymers serving as enclosures or barriers preventing access to hazards		N/A
13.6.2.1	Stress relief test		N/A
13.6.3	Polymers serving as solid insulation		N/A
13.6.3.1	Resistance to arcing		N/A
13.6.4	UV resistance		N/A
	Polymeric parts of an OUTDOOR ENCLOSURE required for compliance with this standard shall be sufficiently resistance to degradation by ultra-violet (UV) radiation		N/A
13.7	Mechanical resistance to deflection, impact, or drop		P
13.7.1	General		P
13.7.2	250-N deflection test for metal enclosures	Applied 250N for 5s	P
13.7.3	7-J impact test for polymeric enclosures		N/A
13.7.4	Drop test		N/A
13.8	Thickness requirements for metal enclosures		P
13.8.1	General	Comply with the applicable tests of 13.7	P
13.8.2	Cast metal		N/A
13.8.3	Sheet metal		P
14	Components		P

IEC/EN 62109-1			
Clause	Requirement – Test	Result - Remark	Verdict
14.1	General	(see appended table)	P
	Where safety is involved, components shall be used in accordance with their specified ratings unless a specific exception is made. They shall conform to one of the following:		P
	a) applicable safety requirements of a relevant IEC standard. Conformity with other requirements of the component standard is not required. If necessary for the application, components shall be subjected to the test of this standard, except that it is not necessary to carry out identical or equivalent tests already performed to check conformity with the component standard;		P
	b) the requirements of this standard and, where necessary for the application, any additional applicable safety requirements of the relevant IEC component standard;		P
	c) if there is no relevant IEC standard, the requirements of this standard;		P
	d) applicable safety requirements of a non-IEC standard which are at least as high as those of the applicable IEC standard, provided that the component has been approved to the non-IEC standard by a recognized testing authority.		P
	Components such as optocouplers, capacitors, transformers, and relays connected across basic, supplemental, reinforced, or double insulation shall comply with the requirements applicable for the grade of insulation being bridged, and if not previously certified to the applicable component safety standard shall be subjected to the voltage test of 7.5.2 as routine test.		P
14.2	Motor Overtemperature Protection		N/A
	Motors which, when stopped or prevented from starting (see 4.4.4.3), would present an electric shock hazard, a temperatur hazard, or a fire hazard, shall be protected by an overtemperature or thermal protection device meeting the requirements of 14.3.		N/A
14.3	Overtemperature protection devices		N/A
14.4	Fuse holders		N/A
14.5	MAINS voltage selecting devices		N/A
14.6	Printed circuit boards		P
	Printed circuit boards shall be made of material with a flammability classification of V-1 of IEC 60707 or better.	V-0	P

IEC/EN 62109-1			
Clause	Requirement – Test	Result - Remark	Verdict
	This requirements does not apply to thin-film flexible printed circuit boards that contain only circuits powered from limited power sources meeting the requirements of 9.2.		N/A
	Conformity of the flammability rating is checked by inspection of data on the materials. Alternatively, conformity is checked by performing the V-1 tests specified in IEC 60707 on three samples of the relevant parts.		N/A
14.7	Circuits or components used as transient overvoltage limiting devices		N/A
	If control of transient overvoltage is employed in the equipment, any overvoltage limiting component or circuit shall be tested with the applicable impulse withstand voltage of Table 7-10 using the test method from 7.5.1 except 10 positive and 10 negative impulses are to be applied and may be spaced up to 1 min apart.		N/A
14.8	Batteries	For external batteries or battery bank, not evaluated in this test report	N/A
	Equipment containing batteries shall be designed to reduce the risk of fire, explosion and chemical leaks under normal conditions and after a single fault in the equipment including a fault in circuitry within the equipment battery pack.		N/A
14.8.1	Battery Enclosure Ventilation		N/A
14.8.1.1	Ventilation requirements		N/A
14.8.1.2	Ventilation testing		N/A
14.8.1.3	Ventilation instructions		N/A
14.8.2	Battery Mounting		N/A
	Compliance is verified by the application of the force to the battery's mounting surface. The test force is to be increased gradually so as to reach the required value in 5 to 10 s, and is to be maintained at that value for 1 min. A nonmetallic rack or tray shall be tested at the highest normal condition operating temperature.		N/A
14.8.3	Electrolyte spillage		N/A
	Battery trays and cabinets shall have an electrolyte-resistant coating.		N/A
	The enclosure or compartment housing a vented battery shall be constructed so that spillage or leakage of the electrolyte from one battery will be contained within the enclosure and be prevented from:		N/A
	a) reaching the PCE outer surfaces that can be contacted by the USER		N/A
	b) contaminating adjacent electrical components		N/A

IEC/EN 62109-1			
Clause	Requirement – Test	Result - Remark	Verdict
	or materials; and		
	c) bridging required electrical distances		N/A
14.8.4	Battery Connections		N/A
	Reverse battery connection of the terminals shall be prevented if reverse connection could result in a hazard within the meaning of this Standard		N/A
14.8.5	Battery maintenance instructions		N/A
	The information and instructions listed in 5.3.4.1 shall be included in the operator manual for equipment in which battery maintenance is performed by the operator, or in the service manual if battery maintenance is to be performed by service personnel only.		N/A
14.8.6	Battery accessibility and maintainability		N/A
	Battery terminals and connectors shall be accessible for maintenance with the correct TOOLS. Batteries with liquid electrolyte, requiring maintained shall be so located that the battery cell caps are accessible for electrolyte tests and readjusting of electrolyte levels.		N/A
15	Software and firmware performing safety functions		N/A
Annex A	Measurement of clearances and creepage distances (see 7.3.7.4 and 7.3.7.5)		P
Annex B	Programmable Equipment		N/A
B.1	Software or firmware that perform safety critical functions		N/A
B.1.1	Firmware or software that performs a critical safety function/s, the failure of which can result in a risk of fire, electric shock or other hazard as specified by this standard, shall be evaluated by one of the following means.		N/A
	a) All software or firmware limits or controls shall be disabled before the test to evaluate the hardware circuitry during the abnormal test condition related to the safety function.		N/A
	b) Protective controls employing software or firmware to perform their function(s), shall be so constructed that they comply with IEC 60730-1 Annex H to address the risks identified in B.2.1.		N/A
B.2	Evaluation of controls employing software		N/A
B.2.1	Risk analysis		N/A
Annex C	Symbols to be used in equipment markings		P

IEC/EN 62109-1			
Clause	Requirement – Test	Result - Remark	Verdict
Annex D	Test probes for determining access		P
Annex E	RCDs		N/A
E.1	Selection of RCD type in AC circuits		N/A
Annex F	Altitude correction for clearances		N/A
Annex G	Clearance and creepage distance determination for frequencies greater than 30 kHz		N/A
G.1	Clearances		N/A
G.2	Creepage distances		N/A
Annex H	Measuring Instrument for Touch Current Measurements		P
H.1	Measuring instrument		P
H.2	Alternative measuring instrument		N/A
Annex I	Examples of Protection, Insulation, and Overvoltage Category Requirements for PCE		N/A
Annex J	Ultraviolet light conditioning test		N/A
J.1	General		N/A
J.2	Mounting of test samples		N/A
J.3	Carbon-arc light-exposure apparatus		N/A
J.4	Xenon-arc light-exposure apparatus		N/A

4.3		TABLE: Heating temperature rise measurements					P
	test voltage (V) Input Voltage.....	207Vac Charge mode	253Vac Charge mode	48Vdc Inverter mode	130Vdc Solar Charge mode	450Vdc Solar Charge mode	—
	t1 (°C) the initial ambient temperature.....	50.0	50.0	50.0	50.0	50.0	—
	t2 (°C) the end ambient temperature...	50.0	50.0	50.0	50.0	50.0	—
Maximum measured temperature T of part/at:		T (°C)					Permitted T _{max} (°C)
Whole unit							
1	Metal enclosure	51.0	47.4	68.4	61.2	63.8	70
2	LCD panel	57.3	58.7	63.3	60.5	58.4	90
3	AC input terminal	74.6	68.0	73.4	63.3	65.1	85
4	PV input terminal	62.3	61.3	72.4	68.7	61.2	85
5	AC output terminal 1	72.0	66.1	77.6	65.0	69.0	85
6	AC output terminal 2	67.2	63.3	76.7	64.6	67.2	85
7	Battery in terminal	60.6	59.5	67.4	60.6	60.6	85
8	AC input wire	78.1	73.7	69.9	65.2	61.6	105
9	PV input wire	63.0	62.2	74.9	73.1	63.2	105
10	AC output wire 1	77.5	69.9	81.9	67.0	73.0	105
11	AC output wire 2	88.0	77.2	86.2	69.2	80.3	105
12	Mounting surface	53.4	53.5	54.2	51.5	50.7	90
On DC-AC Main board							
13	L9 coil	67.1	66.5	73.5	69.7	65.9	130
14	MOV2 body	72.5	69.9	74.4	69.0	65.2	85
15	X-Cap(C11)	88.9	78.3	81.7	68.1	70.5	100
16	L2 coil	130.0	104.0	82.1	68.0	70.7	155
17	Y-Cap(C120)	71.1	77.8	76.4	70.3	66.4	125
18	X-Cap(C89)	76.0	73.7	78.0	69.6	65.6	100
19	RY3 coil	78.5	82.9	76.6	69.0	64.8	110
20	RY1 coil	69.0	76.2	77.0	68.7	64.3	110
21	RY2 coil	71.3	78.8	80.5	71.3	67.4	110
22	X-Cap(C58)	68.7	67.7	79.4	72.2	68.3	100
23	HCT2 coil	77.6	76.7	83.7	74.1	71.4	110
24	MOV1 body	67.8	67.2	79.2	73.2	69.2	85
25	L4 coil	68.9	68.4	83.0	74.9	71.9	130
26	E-Cap(C43)	66.2	65.7	86.4	83.6	76.0	105
27	C33 body	65.5	65.7	75.8	73.0	68.6	Ref.
28	HCT1 coil	69.7	68.6	84.7	76.5	71.3	110

29	TX2 coil	68.4	67.5	79.9	74.5	70.0	120
30	TX9 coil	75.4	75.5	86.5	82.2	77.3	120
31	TX11 coil(On PCB 1)	72.7	77.7	82.0	73.5	69.5	120
32	PCB near QB2	64.0	63.3	92.5	78.5	75.5	130
On SCR board							
33	TX1 coil	67.7	69.2	75.9	68.3	64.3	110
34	TX2 coil	65.4	68.5	76.6	68.7	64.4	Ref.
35	PCB near Q2	68.5	74.3	75.8	68.4	64.4	130
On SPS board							
36	L1 coil	62.9	62.5	72.7	68.2	64.0	130
37	PCB near REC1	64.4	64.3	74.0	70.9	66.8	130
38	E-Cap(C14)	62.8	62.6	71.9	69.0	64.8	105
39	TX1 coil	63.1	63.0	72.2	71.8	68.5	120
40	TX2 coil	63.5	63.2	72.9	87.3	89.4	120
On DC-DC Main board							
41	E-Cap(C10)	64.0	63.5	86.8	70.1	63.7	105
42	TX1 coil(On PC1)	68.0	76.0	80.1	70.6	66.2	110
43	PCB near Q25	64.2	63.4	100.3	69.6	64.8	130
On MPPT board							
44	MOV2 body	64.7	63.9	77.6	70.5	64.3	85
45	L1 coil	65.0	61.8	80.2	127.0	87.0	130
46	HCT1 coil	67.4	66.9	77.0	91.2	71.7	110
47	TX2 coil(On PCB1)	70.2	72.3	79.0	81.4	70.3	120
On COMM board							
48	TX2 coil	70.2	66.8	83.2	71.2	71.8	110
49	TX2 core	72.0	68.8	84.0	72.5	72.9	Ref.
50	U1 body	68.0	64.5	82.8	69.7	70.0	100
On PAR board							
51	TX1 coil	68.2	64.9	76.9	68.0	69.1	110
52	TX1 core	68.7	65.4	77.2	68.4	69.6	Ref.
53	U4 body	66.8	63.1	74.8	65.3	66.7	100
54	U1 body	65.5	61.9	72.9	63.9	65.3	100
On Relay board							
55	RY1 coil	87.5	77.1	89.9	71.1	81.4	110
56	Ambient	50.0	50.0	50.0	50.0	50.0	--
<p>Supplementary information: The minimum input voltage is 130V to work normally on Solar Charge mode. Tests of equipment rated for use in ambient temperatures up to 50 °C may be conducted at any ambient temperature in the range given in 4.2.2.1. PCE rated for use in ambient temperatures more than 50°C shall be tested at the maximum rated ambient temperature ± 5 °C</p>							

4.4		TABLE: Abnormal operation test					P
		ambient temperature (°C) :				See below	
		model/type of power supply :				--	
No.	component No.	fault	test voltage (V)	test time	fuse No.	Input current (A)	Result
Whole unit							
1.	Ventilation	Block	253Vac AC Charge mode	2hrs	Breaker	--	Unit normal operation and shutdown after 90mins, no damage, no hazards. L2 coil on main board: 114.6°C Ambient: 50.0°C
2.	Ventilation	Block	48Vdc Inverter mode	30mins	Fuse	--	Unit shutdown after 20mins, no damaged, no hazards.
3.	Ventilation	Block	240Vdc Solar Charge mode	50mins	Fuse	--	Unit normal operation and shutdown after 40mins, no damaged, no hazards.
4.	DC Fan	Lock	253Vac AC Charge mode	2hrs	Breaker	--	Unit normal operation, no damaged, no hazards. L2 coil on main board: 109.6°C Ambient: 50.0°C
5.	DC Fan	Lock	48Vdc Inverter mode	40mins	Fuse	--	Unit normal operation and shutdown after 30mins, no damaged, no hazards.
6.	DC Fan	Lock	240Vdc Solar Charge mode	1hr 30mins	Fuse	--	Unit normal operation, no damaged, no hazards.
7.	AC Output	O-L	253Vac AC Charge mode	30mins	Breaker	--	Unit "07" alarm and shutdown after 10mins, no damaged, no hazards.
8.	AC Output	O-L	48Vdc Inverter mode	10mins	Fuse	--	Unit shutdown immediately, no damaged, no hazards.
9.	AC Output	O-L	240Vdc Solar Charge mode	10mins	Fuse	--	Unit shutdown immediately, no damaged, no hazards.
10.	AC Output	S-C	253Vac AC Charge mode	5mins	Breaker	--	Unit output shutdown. Fault was displayed, no damaged, no hazards.
11.	AC Output	S-C	48Vdc Inverter mode	5mins	Fuse	--	Unit output shutdown. Fault was displayed, no damaged, no hazards.
12.	AC Output	S-C	240Vdc Solar Charge mode	5mins	Fuse	--	Unit output shutdown. Fault was displayed, no damaged, no hazards.
Main board							

13.	C13	S-C	48Vdc Inverter mode	5mins	Fuse	0.01	Unit shutdown immediately. F3 open, C13, C12, C9 damaged, no hazards.
14.	Q11 Pin D-S	S-C	48Vdc Inverter mode	5mins	Fuse	0.01	Unit shutdown immediately. F3 open, Q11, Q13, Q17, Q18, Q20, Q23, Q24 damaged, no hazards.
15.	Q11 Pin G-S	S-C	48Vdc Inverter mode	5mins	Fuse	0.01	Unit shutdown immediately. F3 open, Q11, Q13, Q17, Q18, Q20, Q23, Q24 damaged, no hazards.
16.	Q11 Pin G-D	S-C	48Vdc Inverter mode	5mins	Fuse	0.01	Unit shutdown immediately. F3 open, Q11, Q13, Q17, Q18, Q20, Q23, Q24 damaged, no hazards.
17.	Q58 Pin E-C	S-C	48Vdc Inverter mode	5mins	Fuse	0.01	Unit shutdown immediately. Fault was displayed. Q58, Q45, Q29, Q35, Q31, Q28 damaged, no hazards.
18.	Q58 Pin G-E	S-C	48Vdc Inverter mode	5mins	Fuse	0.01	Unit shutdown immediately. Fault was displayed. Q58, Q45, Q29, Q35, Q31, Q28 damaged, no hazards.
19.	Q58 Pin G-C	S-C	48Vdc Inverter mode	5mins	Fuse	0.01	Unit shutdown immediately. Fault was displayed. Q58, Q45, Q29, Q35, Q31, Q28 damaged, no hazards.
20.	Q58 Pin E-C	S-C	253Vac AC Charge mode	5mins	Breaker	0.01	Unit shutdown immediately. Fault was displayed. Q58, Q45, Q29, Q35, Q31, Q28 damaged, no hazards.
21.	Q58 Pin G-E	S-C	253Vac AC Charge mode	5mins	Breaker	0.01	Unit shutdown immediately. Fault was displayed. Q58, Q45, Q29, Q35, Q31, Q28 damaged, no hazards.
22.	Q58 Pin G-C	S-C	253Vac AC Charge mode	5mins	Breaker	0.01	Unit shutdown immediately. Fault was displayed. Q58, Q45, Q29, Q35, Q31, Q28 damaged, no hazards.
23.	Q34 Pin1-2	S-C	253Vac AC Charge mode	5mins	Breaker	0.01	Unit changer battery mode, Q34 damaged, no hazards.
24.	Q34 Pin2-3	S-C	253Vac AC Charge mode	5mins	Breaker	0.01	Unit changer battery mode, Q34 damaged, no hazards.
25.	Q34 Pin1-3	S-C	253Vac AC Charge mode	5mins	Breaker	0.01	Unit changer battery mode, Q34 damaged, no hazards.
26.	Q61 Pin D-S	S-C	253Vac AC Charge mode	5mins	Breaker	0.01	Unit shutdown immediately, Warning sound, Fault was displayed, Q61 damaged, no hazards.

27.	Q61 Pin G-S	S-C	253Vac AC Charge mode	5mins	Breaker	0.01	Unit shutdown immediately, Warning sound, Fault was displayed, Q61 damaged, no hazards.
28.	Q61 Pin G-D	S-C	253Vac AC Charge mode	5mins	Breaker	0.01	Unit shutdown immediately, Warning sound, Fault was displayed, Q61 damaged, no hazards.
29.	TX5 Pin13-14	S-C	253Vac AC Charge mode	5mins	Breaker	0.01	Unit shutdown immediately, Warning sound, Fault was displayed, no hazards.
SPS board							
30.	REC1 Pin1-3	S-C	253Vac AC Charge mode	5mins	Breaker	0.01	Unit shutdown immediately. Fault was displayed.REC1 damaged, no hazards.
31.	Q1 Pin G to S	S-C	253Vac AC Charge mode	5mins	Breaker	0.01	Unit shutdown immediately. Fault was displayed.Q1 damaged, no hazards.
32.	Q1 Pin G to D	S-C	253Vac AC Charge mode	5mins	Breaker	0.01	Unit shutdown immediately, Fault was displayed. Q1 damaged, no hazards.
33.	Q1 Pin D to S	S-C	253Vac AC Charge mode	5mins	Breaker	0.01	Unit shutdown immediately, Fault was displayed.Q1 damaged, no hazards.
MPPT board							
34.	Q2 Pin E-C	S-C	240Vdc Solar Charge mode	5mins	Fuse	0.01	Unit shutdown immediately. Fault was displayed.Q1, R11, D3 damaged, no hazards.
35.	Q2 Pin G-E	S-C	240Vdc Solar Charge mode	5mins	Fuse	0.01	Unit shutdown immediately. Fault was displayed.Q1, R11, D3 damaged, no hazards.
36.	Q2 Pin G-C	S-C	240Vdc Solar Charge mode	5mins	Fuse	0.01	Unit shutdown immediately. Fault was displayed.Q1, R11, D3 damaged, no hazards.
COMM board							
37.	TX2	O-L	253Vac AC Charge mode	5mins	Breaker	31.2	Unit working normal. Displayed shutdown, no hazards.
38.	TX2 Pin9-10	S-C	253Vac AC Charge mode	5mins	Breaker	0.01	Unit working normal. Displayed shutdown, no hazards.
39.	U1 Pin1-2	S-C	253Vac AC Charge mode	5mins	Breaker	0.01	Unit working normal. displayed shutdown, no hazards.
PAR board							

40.	TX1	O-L	253Vac AC Charge mode	5mins	Breaker	0.01	Parallel communication Abnormal, Fault was displayed, no hazards.
41.	TX1 Pin7-8	S-C	253Vac AC Charge mode	5mins	Breaker	0.01	Parallel communication Abnormal, Fault was displayed, no hazards.
Supplementary information:							

4.7	TABLE: Electrical data in normal condition						P
Type	U (V) Input	I (A) Input	P (W) Input	U (V) Output	I (A) Output	P (W) Output	
AC supply mode	207Vac/50Hz	40.38	8358	206.73	38.76	8024	
	230Vac/50Hz	36.29	8347	229.9	34.85	8013	
	253Vac/50Hz	33.37	8443	253	32.04	8105	
	207Vac/60Hz	40.38	8358	206.73	38.81	8024	
	230Vac/60Hz	36.29	8347	229.9	34.85	8013	
	253Vac/60Hz	33.37	8443	253	32.04	8105	
Solar charge mode	90Vdc	0	0	0	0	0	
	130Vdc	43.92	5709	230.02	23.06	5309	
	240Vdc	35.93	8624	229.8	34.90	8020	
	450Vdc	19.21	8643	230.18	34.92	8038	
	500Vdc	0	0	0	0	0	
Inverter mode	48Vdc	172.47	8624	229.8	34.90	8020	
Remark: The device does not function properly when the input voltage is 90V and 500V on Solar charge mode.							

7.3.6.3.3	TABLE: Protective bonding impedance test			P
Location	Resistance measured(mΩ)	Voltage measured(V)	Comments	
PE pole of input terminal block to metal enclosure the most distance	--	0.274	Test current of 140A, duration of 6min	
Input PE to output PE	--	0.05	Test current of 140A, duration of 6min	
Supplementary information:				

7.3.2.6/ 7.3.7.5.2	Table: Working Voltage Measurement			P
Supply Voltage: <u>230</u> V <u>60</u> Hz				
Location	RMS voltage (V)	Peak voltage (V)	Comments	
Comm board				
TX2 pin 2 to 8	209	364		
TX2 pin 2 to 9	208	312		
TX2 pin 2 to 10	209	388		

TX2 pin 4 to 8	210	404	The Max Vpeak and Vrms
TX2 pin 4 to 9	208	340	
TX2 pin 4 to 10	208	344	
U1 pin 1 to 3	208	302	
U1 pin 1 to 4	208	306	
U1 pin 2 to 3	194	320	
U1 pin 2 to 4	191	307	
U6 pin 1 to 3	208	310	
U6 pin 1 to 4	209	310	
U6 pin 2 to 3	208	306	
U6 pin 2 to 4	208	310	
PAR board			
TX1 Pin1-7	26.1	53.0	
TX1 Pin1-8	27.3	54.7	
TX1 Pin4-7	37.8	88.0	The Max Vpeak and Max Vrms
TX1 Pin4-8	32.7	73.4	
U1 Pin1-3	22.3	48.3	
U1 Pin1-4	21.0	49.2	
U1 Pin2-3	24.1	48.3	
U1 Pin2-4	19.2	46.2	
U3 Pin1-3	22.6	45.3	
U3 Pin1-4	21.3	47.8	
U3 Pin2-3	22.0	45.6	
U3 Pin2-4	19.9	45.2	
U7 Pin1-3	20.6	46.3	
U7 Pin1-4	20.1	45.9	
U7 Pin2-3	19.8	46.8	
U7 Pin2-4	18.6	47.6	
U8 Pin1-3	22.1	48.2	
U8 Pin1-4	20.6	45.3	
U8 Pin2-3	19.9	45.1	
U8 Pin2-4	20.5	47.3	
U9 Pin1-3	20.8	46.5	
U9 Pin1-4	20.4	45.1	
U9 Pin2-3	19.6	45.6	
U9 Pin2-4	20.3	44.9	
U10 Pin1-3	21.5	45.3	
U10 Pin1-4	19.7	45.7	
U10 Pin2-3	21.3	46.7	

U10 Pin2-4	20.5	46.2	
U4 Pin1-5	22.6	44.9	
U4 Pin1-6	23.0	45.6	
U4 Pin1-7	21.5	46.7	
U4 Pin1-8	20.4	45.3	
U4 Pin2-5	21.0	44.7	
U4 Pin2-6	19.6	44.6	
U4 Pin2-7	19.9	45.8	
U4 Pin2-8	20.6	47.3	
U4 Pin3-5	21.3	45.9	
U4 Pin3-6	20.3	46.2	
U4 Pin3-7	20.7	43.8	
U4 Pin3-8	21.0	44.8	
U4 Pin4-5	20.6	46.9	
U4 Pin4-6	21.5	48.2	
U4 Pin4-7	22.4	44.6	
U4 Pin4-8	20.6	45.8	
U6 Pin1-5	19.9	47.6	
U6 Pin1-6	19.5	45.3	
U6 Pin1-7	19.3	42.2	
U6 Pin1-8	18.0	42.8	
U6 Pin2-5	18.6	41.6	
U6 Pin2-6	19.4	42.5	
U6 Pin2-7	20.1	45.1	
U6 Pin2-8	19.6	42.6	
U6 Pin3-5	20.1	45.8	
U6 Pin3-6	20.5	44.9	
U6 Pin3-7	21.6	44.8	
U6 Pin3-8	19.9	43.6	
U6 Pin4-5	19.0	43.7	
U6 Pin4-6	20.5	42.5	
U6 Pin4-7	21.0	44.8	
U6 Pin4-8	20.3	43.8	
Supplementary information:			

7.3.7	TABLE: Clearance and creepage distance measurements						P
Clearance cl and creepage distance dcr at / of:	Up (V)	U r.m.s. (V)	U impulse (V)	Required cl (mm)	cl (mm)	Required dcr (mm)	dcr (mm)
Primary circuit to Ground on PCB(B)	<420	<250	4000	3.0	3.8	3.0	3.8

7.3.7	TABLE: Clearance and creepage distance measurements						P
Clearance cl and creepage distance dcr at / of:	Up (V)	U r.m.s. (V)	U impulse (V)	Required cl (mm)	cl (mm)	Required dcr (mm)	dcr (mm)
Live part to metal enclosure (B)	<420	<250	4000	3.0	>6.3	3.0	>6.3
PAR board							
Transformers TX1 primary winding to secondary winding(R)	<420	<250	6000	5.5	7.6	5.5	7.6
Transformers TX1 primary winding to core(B)	<420	<250	4000	3.0	3.8	3.0	3.8
Transformers TX1 secondary winding to core(B)	<420	<250	4000	3.0	3.8	3.0	3.8
Opto-coupler(U1, U3, U7, U8, U9, U10)(R)	<420	<250	6000	5.5	6.0	5.5	6.0
Opto-coupler(U4, U6)(R)	<420	<250	6000	5.5	6.2	5.5	6.2
COMM board							
Primary circuit to SELV circuit under U1, U6(R)	<420	<250	6000	5.5	6.6	5.5	6.6
Primary circuit to SELV circuit under TX2(R)	<420	<250	6000	5.5	6.3	5.5	6.3
Main board							
Primary circuit to Battery circuit under TX9(B)	<420	<250	4000	3.0	>6.3	3.0	>6.3
Primary circuit to Battery circuit under TX2(B)	<420	<250	4000	3.0	>6.3	3.0	>6.3
Primary circuit to Battery circuit under TX1, TX3 (B)	<420	<250	4000	3.0	3.0	3.0	3.0
Primary circuit to Battery circuit under TX5, TX8(B)	<420	<250	4000	3.0	>6.3	3.0	>6.3
Primary circuit to Battery circuit under U8, U13, U17(B)	<420	<250	4000	3.0	6.5	3.0	6.5
Supplementary information:							
1. For PV circuit, system voltage is 500V and overvoltage category is OVC II, impulse voltage correspond to PV circuit is 2500 V;							
2. For AC mains circuit, nominal voltage is 230 V and overvoltage category is OVC III, impulse voltage correspond to mains circuit is 4000 V;							
3. For insulations between live parts, which PV circuit and mains circuit is not isolated, Mains voltage 230 V is considered for the maximum working voltage							
4. F: function insulation B: Basic insulation S: Supplementary insulation R: Reinforced insulation							

7.3.7.8.3.2 to 7.3.7.8.3.3	TABLE: Distance through insulation measurement			P
Distance through insulation di at/of:	U r.m.s. (V)	Test voltage (V)	Required di (mm)	di (mm)
Opto-coupler	<250	3000Vac	>0.4	>0.4
Bobbin of TX1 on PAR board	<250	3000Vac	>0.4	>0.4
Bobbin of TX2 on COMM. board	<250	3000Vac	>0.4	>0.4

Supplementary information:

7.3.9	TABLE: Discharge of stored energy test				P
Condition	Tcalculated (s)	Tmeasured DVC A (s)	tu→0V DVC A(s)	Comments	
DC Bus capacitor	--	--	--	After 8S, voltage drop to 22V	
Note(s): 1) Supplied by <u> 253 </u> V/ <u> 60 </u> Hz					

7.5	TABLE: Electric strength measurements, impulse voltage test and partial discharge test				P
Test voltage applied between:	Test voltage (V)	Impulse withstand voltage (V)	Partial discharge extinction voltage (V)	Result	
Primary circuit to earthed enclosure	1500Vac	4000V	N/A	No breakdown	
Primary circuit to non-earth accessible part	3000Vac	6000V	N/A	No breakdown	
Primary circuit to SELV circuits	3000Vac	6000V	N/A	No breakdown	
Transformers TX2(on COMM board) primary winding to core	1500Vac	4000V	N/A	No breakdown	
Transformers TX2(on COMM board) secondary winding to core	1500Vac	4000V	N/A	No breakdown	
Transformers TX2(on COMM board) primary winding to secondary winding	3000Vac	6000V	N/A	No breakdown	
Transformers TX1(on PAR board) primary winding to core	1500Vac	4000V	N/A	No breakdown	
Transformers TX1(on PAR board) secondary winding to core	1500Vac	4000V	N/A	No breakdown	
Transformers TX1(on PAR board) primary winding to secondary winding	3000Vac	6000V	N/A	No breakdown	
Supplementary information:					

7.5.4	TABLE: Touch current measurement			P
Condition	Dangerous conductive parts	Limit (mA)	Comments	
AC supply mode	L/N to metal enclosure	3.5	Measured: 7.2mA Warning symbol provided	
AC supply mode	L/N to non-conductive part	0.25	Measured: 0.01mA	
Note(s): Test voltage: <u> 253 </u> V/ <u> 60 </u> Hz				

9.1.4	TABLE: Openings		N/A
Location	Size (mm)	Comments	

Top	---	No openings
Side	---	No openings
Bottom	---	No openings
Front	---	No openings
Back	---	No openings
Supplementary information: In wall mount mode, LCD on the front side		

9.2	TABLE: Limited power sources					P
Note: Measured Uoc (V) with all load circuits disconnected:						
Components	Current (rated) (A)	Uoc (V)	I _{sc} (A)		VA	
			Meas.	Limit	Meas.	Limit
DC output port	--	12.2	1.46	8	15.3	100
USB port	--	4.3	1.42	8	4.5	100
COM port	--	12.39	1.37	8	8.3	100
BMS port	--	12.2	0	8	0	100
Supplementary information: No output voltage on other communication ports						

10.2.1	TABLE: Sound level		N/A
Locations tested	Measured values (dBA)	Calculated maximum sound pressure level	
At operator's normal position and at bystanders' positions			
a) 90°, 1 meter	--	--	
b) 0°, 1 meter	--	--	
c) 180°, 1 meter	--	--	
d) 270°, 1 meter	--	--	
Note(s):			

14	TABLE: list of critical components					P
Object / part No.	Manufacturer/ trademark	Type / model	Technical data	Standard	Mark(s) of conformity ¹	
Whole unit						
Enclosure Case	Interchangeable	Interchangeable	Mini Thickness: 1.5mm	IEC 62109-1 IEC 62109-2	Tested with appliance	
Cable Glands	Interchangeable	Interchangeable	V-2mm ,85°C	UL94	UL	
Terminal Block (Input / Output)	SHENZHEN SUCCEED ELECTRONIC	TD90	600Vac, 90A	UL486	UL E332956	
Breaker	KUOYUH W L ENTERPRISE CO LTD	98H Series	250Vac,70A	UL1077	UL E155159	
Fan (Three provide)	SHENZHEN HUAXIA HENGTAI ELECTRONIC CO LTD	DZ08038B12HH	12Vdc, 0.55A CFM 70.22	EN IEC 62368-1 UL 507	TUV 1111226031 UL E254715	
(Alternative)	SHENZHEN YCCFAN TECHNOLOGY CO LTD	YDH8038B12	12Vdc, 0.51A CFM 65.48	EN IEC 62368-1, UL 507	TUV 50488336 UL E465296	
DC-DC Main board						
Fuse (F1)	Interchangeable	BUS BAR Size:42*12*0.6m m	70Vdc, 200A/ 70Vdc, 150A.	IEC 62109-1 IEC 62109-2	Tested with appliance	
(Alternative)	WOG Precision ELECTRICAL CO LTD	AN498	58Vdc, 150A.	UL248	UL cUL E510943	
Y-Capacitor (C70, C71) Option	JUSUN (TAISHAN) ELECTRONICS LTD	JA	Max. 10nF Min. 250Vac, 85°C	IEC/EN60384- 14 UL1414	ENEC 01805-M2 UL E253194	
X-Capacitor (C72, C73, C150 ,C151)	WINDAY ELECTRONIC (DONG GUAN) CO LTD	MPX	0.22uF/310V 100°C	IEC/EN60384-14 UL1414	VDE 40030283 UL E302125	
Capacitor (C8, C9, C10, C12, C14, C15, C18, C24, C53, C86)	Interchangeable	Interchangeable	5600uF/80Vdc	IEC 62109-1 IEC 62109-2	Tested with appliance	
MOSFET (Q13, Q1 7~Q20, Q22, Q24, Q25, Q33, Q38~Q40)	Interchangeable	Interchangeable	200V, 130A	IEC 62109-1 IEC 62109-2	Tested with appliance	
PCB	Interchangeable	Interchangeable	V-0, 130 C	UL94	UL	
DC-AC Main board						
Varistor (MOV2, MOV3)	BRIGHTKING (SHENZHEN) CO LTD	751KN20	460Vac, 615Vdc (Coating min. V-1)	UL 1449 4th Ed	UL E472693	
Varistor (MOV1)	THINKING ELECTRONIC INDUSTRIAL CO LTD	TVT20561	350Vac, 460Vdc (Coating min. V-1)	IEC 61051-1 IEC 61051-2 IEC 61051-2-2, UL 1449, SPD Type 3	TUV 1419068445 UL E314979	
X-Capacitor (C59, C60) Option	SHENZHEN JINGHAO CAPACITOR CO	CBB62B	0.1uF/280V 110°C	IEC/EN60384- 14 UL1414	VDE 40018690 UL E252286	

	LTD				
X-Capacitor (C58)	SHENZHEN JINGHAO CAPACITOR CO LTD	CBB62B	0.47uF/280Vac, 110°C	IEC/EN60384-14 UL1414	VDE 40018690 UL E252286
X-Capacitor (C11)	WINDAY ELECTRONIC (DONG GUAN) CO LTD	MPX	1.5uF/275Vac, 100°C	IEC/EN60384-14 UL1414	VDE 40030283 UL E302125
Relay (RY1)	TAIWAN SHORI ELECTRIC CO LTD	S25H-12VDC-2CS	30A/250V	EN 61810-1 IEC61810-1	TUV R50345594
Relay (RY2,RY3)	TAIWAN SHORI ELECTRIC CO LTD	S25H-12VDC-2AS	30A/250V	EN 61810-1 IEC61810-1	TUV R50345594
Choke (L2, L4)	CLICK	41-110067-xxG	2.1mH , 130°C	IEC 62109-1 IEC 62109-2	Tested with appliance
MOSFET (Q6)	Interchangeable	Interchangeable	500V,8A	IEC 62109-1 IEC 62109-2	Tested with appliance
IGBT (QA1, QA2, QB 2, QB3, QC1, Q C2, QD2, QD3, Q27~Q32, Q3 5, Q37, Q42, Q45)	Interchangeable	Interchangeable	650V, 60A	IEC 62109-1 IEC 62109-2	Tested with appliance
Capacitor (C40,C41)	Interchangeable	Interchangeable	680uF/500Vdc	IEC 62109-1 IEC 62109-2	Tested with appliance
Transformer (TX2)	DONGGUAN RONGCHYUAN ELECTRIC MFG CO LTD	41-070186-xxG	130°C	IEC 62109-1 IEC 62109-2	Tested with appliance
Transformer (TX9)	ZHEJANG TONGDA	41-070802-xxG	130°C	IEC 62109-1 IEC 62109-2	Tested with appliance
PCB	Interchangeable	Interchangeable	V-0, 130 C	UL94	UL
DC-AC DRIVE board					
Transformer (TX7)	CLICK	41-070184-xxG	130°C	IEC 62109-1 IEC 62109-2	Tested with appliance
(Alternative)	DONGGUAN RONGCHYUAN ELECTRIC MFG CO LTD	41-070184-xxG	130°C	IEC 62109-1 IEC 62109-2	Tested with appliance
PCB	Interchangeable	Interchangeable	V-0, 130 C	UL94	UL
CHOKE board					
Transformer (TX1, TX3, TX4)	Voltronic	Z41-07A032-00G	130°C	IEC 62109-1 IEC 62109-2	Tested with appliance
PCB	Interchangeable	Interchangeable	V-0, 130 C	UL94	UL
SCR board					
Transformer (TX1,TX2)	DONGGUAN RONGCHYUAN ELECTRIC MFG CO LTD	41-040046-xxG	130°C	IEC 62109-1 IEC 62109-2	Tested with appliance
(Alternative)	CLICK	41-040046-xxG	130°C	IEC 62109-1 IEC 62109-2	Tested with appliance
SCR (Q1~Q4)	Interchangeable	Interchangeable	70A,1200Vac	IEC 62109-1 IEC 62109-2	Tested with appliance
PCB	Interchangeable	Interchangeable	V-0, 130°C	UL94	UL

MPPT board					
Varistor (MOV1~MOV 4)	THINKING ELECTRONIC INDUSTRIAL CO LTD	TVT20751	350Vac, 460Vdc (Coating min. V-1)	IEC 60950-1: EN 61051-1 IEC 61051-2 IEC 61051-1 IEC 61051-2-2 UL 1449	TUV 1419068445 UL E314979
Y-Capacitor (C1, C2, C11, C12, C35, C36) Option	JUSUN (TAISHAN) ELECTRONICS LTD	JA	Max. 1nF Min. 250Vac, 85°C	IEC/EN60384-14 UL1414	ENEN 01805-M2 UL E253194
Choke (L1)	MAOHONG	41-110268-xxG	2.5mH, 1.7mm*2, 130°C	IEC 62109-1 IEC 62109-2	Tested with appliance
IGBT (Q2,Q5)	Interchangeable	Interchangeable	650V, 80A	IEC 62109-1 IEC 62109-2	Tested with appliance
Diode (D1,D24)	Interchangeable	Interchangeable	600V,30A	IEC 62109-1 IEC 62109-2	Tested with appliance
PCB	Interchangeable	Interchangeable	V-0, 130°C	UL94	UL
SPS board					
X-Capacitor (C2)	WINDAY ELECTRONIC (DONG GUAN) CO LTD	MPX	0.22uF/310V 100°C	IEC/EN60384-14 UL1414	VDE 40030283 UL E302125
Y-Capacitor (C4, C5, C8, C9) Option	JUSUN (TAISHAN) ELECTRONICS LTD	JA	Max. 4.7nF Min. 250Vac, 85°C	IEC/EN60384-14 UL1414	ENEN 01805-M2 UL E253194
Choke (L1)	Interchangeable	41-110088-xxG	110uH, 0.65mm, 130°C	IEC 62109-1 IEC 62109-2	Tested with Appliance
Fuse (F1)	HOLLY	20N-030H	3A, 250Vac	UL248	UL, cUL E156471
Transformer (TX1,TX2)	DONGGUAN RONGCHYUAN ELECTRIC MFG CO LTD	41-070805-xxG	130°C	IEC 62109-1 IEC 62109-2	Tested with appliance
(Alternative)	Voltronic	Z41-070805-xxG	130°C	IEC 62109-1 IEC 62109-2	Tested with appliance
IGBT (Q1,Q2)	Interchangeable	Interchangeable	800V,11A	IEC 62109-1 IEC 62109-2	Tested with appliance
Bridge (REC1)	Interchangeable	Interchangeable	1000V,4A	IEC 62109-1 IEC 62109-2	Tested with appliance
Photo coupler (U3,U7)	COSMO	K1010	Dti = 0.7 mm, Int. dcr =5.3mm, Ext. dcr =8.0mm, 115°C	UL1577 IEC 60747-5-2 IEC 60950-1 DIN EN 60747-5-5 (0884-5):2015-11; EN 60747-5-5:2011; A1:2015	UL E169586 VDE 101347
PCB	Interchangeable	Interchangeable	V-0, 130°C	UL94	UL
PAP board					
Transformer (TX1)	DONGGUAN RONGCHYUAN ELECTRIC MFG CO LTD	41-070193-xxG	Class A	IEC 62109-1 IEC 62109-2	Tested with appliance
Photo coupler (U1, U3, U7~U10)	COSMO	K1010	Dti = 0.7 mm, Int. dcr =5.3mm, Ext. dcr =8.0mm, 115°C	UL1577 IEC 60747-5-2 IEC 60950-1 DIN EN 60747-5-5 (0884-5):2015-	UL E169586 VDE 101347

				11; EN 60747-5-5:2011; A1:2015	
Relay (RY2)	XIAMEN HONGFA ELECTROACOUSTIC CO LTD	HFD3	30Vdc,2A	EN 61810-1 IEC61810-1 UL508 UL 60947-1 CSA-C22.2 No. 14 CSA-C22.2 No. 60947-4-1	TUV 1419067863 UL, cUL E133481
PCB	Interchangeable	Interchangeable	V-0, 130°C	UL94	UL
Comm board					
Photo Coupler (U1, U6, U8, U10, U15, U16)	COSMO	K1010	Dti = 0.7 mm, Int. dcr =5.3mm, Ext. dcr =8.0mm, 115°C	UL1577 IEC 60747-5-2 IEC 60950-1 DIN EN 60747-5-5 (0884-5):2015-11; EN 60747-5-5:2011; A1:2015	UL E169586 VDE 101347
Transformer (TX2)	CLICK	41-070890-xxG	Class B	IEC 62109-1 IEC 62109-2	Tested with appliance
(Alternative)	DONGGUAN RONGCHYUAN ELECTRIC MFG CO LTD	41-070890-xxG	Class B	IEC 62109-1 IEC 62109-2	Tested with appliance
(Alternative)	SHENZHEN YIXINGWENDA	41-070890-xxG	Class B	IEC 62109-1 IEC 62109-2	Tested with appliance
PCB	Interchangeable	Interchangeable	V-0, 130°C	UL94	UL
Relay board					
Relay (RY1)	SHORI	S12H-PAS-12	40A, 277V/250V	IEC 61810-1:2015 EN 61810-1:2015 UL508	TUV R 50360420 UL E188091
Supplementary information:					

IEC/EN 62109-2			
Clause	Requirement – Test	Result - Remark	Verdict
4	General testing requirements		P
	This clause of part 1 is applicable except as follows		---
4.4	Testing in single fault condition		P
4.4.4	Single fault conditions to be applied: Add the following requirements:		P
4.4.4.15	Fault-tolerance of protection for grid-interactive inverters	Not grid-interactive inverter	N/A
4.4.4.15.1	Fault-tolerance of residual current monitoring		N/A
	Where protection against hazardous residual currents according to 4.8.3.5 is required, the residual current monitoring system must be able to operate properly with a single fault applied, or must detect the fault or loss of operability and cause the inverter to indicate a fault and disconnect from or not connect to the MAINS, no later than the next attempted re-start.		N/A
	Compliance is checked by testing with the grid-interactive inverter connected as in reference test conditions in Part 1. Single faults are to be applied in the inverter one at a time, for example in the residual current monitoring circuit, other control circuits, or in the power supply to such circuits. For each fault condition, the inverter complies if one of the following occurs:		N/A
	a) the inverter ceases to operate, indicates a fault in accordance with 13.9, disconnects from the mains, and does not re-connect after any sequence of removing and reconnecting PV power, AC power, or both,		N/A
	or b) the inverter continues to operate, passes testing in accordance with 4.8.3.5 showing that the residual current monitoring system functions properly under the single fault condition, and indicates a fault;		N/A
	or c) the inverter continues to operate, regardless of loss of residual current monitoring functionality, but does not re-connect after any sequence of removing and reconnecting PV power, AC power, or both, and indicates a fault.		N/A
4.4.4.15.2	Fault-tolerance of automatic disconnecting means	Approved relays disconnect all line conductors from the mains. An isolation transformer is connected external in series to the grid.	P
4.4.4.15.2.1	General		P
	The means provided for automatic disconnection of a grid-interactive inverter from the mains shall:	Disconnected all line conductors from the mains	P

IEC/EN 62109-2			
Clause	Requirement – Test	Result - Remark	Verdict
	– disconnect all grounded and ungrounded current-carrying conductors from the mains, and		P
	– be such that with a single fault applied to the disconnection means or to any other location in the inverter, at least basic insulation or simple separation is maintained between the PV array and the mains when the disconnecting means is intended to be in the open state.	An isolation transformer is connected external in series to the grid.	P
4.4.4.15.2.2	Design of insulation or separation		P
	The design of the basic insulation or simple separation referred to in 4.4.4.15.2.1 shall comply with the following:		P
	– the basic insulation or simple separation shall be based on the PV circuit working voltage, impulse withstand voltage, and temporary over-voltage, in accordance with 7.3.7 of Part 1;		P
	– the mains shall be assumed to be disconnected;		P
	– the provisions of 7.3.7.1.2 g) of Part 1 may be applied if the design incorporates means to reduce impulse voltages, and where required by 7.3.7.1.2 of Part 1, monitoring of such means;		P
	– in determining the clearance based on working voltage in 7.3.7 of Part 1, the values of column 3 of Table 13 of Part 1 shall be used.		P
4.4.4.15.2.3	Automatic checking of the disconnect means	Isolated inverter	N/A
	For a non-isolated inverter, the isolation provided by the automatic disconnection means shall be automatically checked before the inverter starts operation. If the isolation check fails, the inverter shall not close any still-functional disconnection means, shall not start operation, and shall indicate a fault in accordance with 13.9.		N/A
	Compliance is checked by inspection of the PCE and schematics, evaluation of the insulation or separation provided by components, and for non-isolated inverters by the following test:		N/A
	With the non-isolated grid-interactive inverter connected and operating as in reference test conditions in Part 1, single faults are to be applied to the automatic disconnection means or to other relevant parts of the inverter. The faults shall be chosen to render all or part of the disconnection means inoperable, for example by defeating control means or by short circuiting one switch pole at a time. With the inverter operating, the fault is applied, and then PV input voltage is removed or lowered below the minimum required for inverter operation, to trigger a disconnection from the mains.		N/A

IEC/EN 62109-2			
Clause	Requirement – Test	Result - Remark	Verdict
	The PV input voltage is then raised back up into the operational range. After the inverter completes its isolation check, any still-functional disconnection means shall be in the open position, at least basic insulation or simple separation shall be maintained between the PV input and the mains, the inverter shall not start operation, and the inverter shall indicate a fault in accordance with 13.9.		
	In all cases, the non-isolated grid-interactive inverter shall comply with the requirements for basic insulation or simple separation between the mains and the PV input following application of the fault.		N/A
4.4.4.16	Stand-alone inverters - load transfer test		N/A
	A stand-alone inverter with a transfer switch to transfer AC loads from the mains or other AC bypass source to the inverter output shall continue to operate normally and shall not present a risk of fire or shock as the result of an out-of-phase transfer.	No such transfer switch	N/A
	Compliance is checked by the following test. The bypass a.c. source is to be displaced 180° from the a.c. output of a single-phase inverter and 120° for a 3-phase supply. The transfer switch is to be subjected to one operation of switching the load from the a.c. output of the inverter to the bypass a.c. source. The load is to be adjusted to draw maximum rated a.c. power.		N/A
	For an inverter employing a bypass switch having a control preventing switching between two a.c. sources out of synchronization, the test is to be conducted under the condition of a component malfunction when such a condition could result in an out-of-phase transfer between the two a.c. sources of supply.		N/A
4.4.4.17	Cooling system failure – Blanketing test		P
	In addition to the applicable tests of subclause 4.4.4.8 of Part 1, inadvertent obstruction of the airflow over an exposed external heatsink shall be one of the fault conditions considered. No hazards according to the criteria of subclause 4.4.3 of Part 1 shall result from blanketing the inverter in accordance with the test below.	See appended table	P
	This test is not required for inverters restricted to use only in closed electrical operating areas.		N/A
	Compliance is checked by the following test, performed in accordance with the requirements of subclause 4.4.2 of Part 1 along with the following.		P
	The inverter shall be mounted in accordance with the manufacturer’s installation instructions. If more than one position or orientation is allowed, the test	See appended table	P

IEC/EN 62109-2			
Clause	Requirement – Test	Result - Remark	Verdict
	shall be performed in the orientation or position that is most likely to result in obstruction of the heatsink after installation. The entire inverter including any external heatsink provided shall be covered in surgical cotton with an uncompressed thickness of minimum 2 cm, covering all heatsink fins and air channels. This surgical cotton replaces the cheesecloth required by subclause 4.4.3.2 of Part 1. The inverter shall be operated at full power. The duration of the test shall be a minimum of 7 h except that the test may be stopped when temperatures stabilize if no external surface of the inverter is at a temperature exceeding 90 °C.		
4.7	Electrical Ratings Tests		P
4.7.3	Measurement requirements for AC output ports for stand-alone inverters		P
	Measurements of the AC output voltage and current on a stand-alone inverter shall be made with a meter that indicates the true RMS value.	See below	P
4.7.4	Stand-alone Inverter AC output voltage and frequency		P
4.7.4.1	General The AC output voltage and frequency of a stand-alone inverter, or multi-mode inverter operating in stand-alone mode, shall comply with the requirements of 4.7.4.2 to 4.7.4.5.		P
4.7.4.2	Steady state output voltage at nominal DC input	See appended table.	P
	The steady-state AC output voltage shall not be less than 90 % or more than 110 % of the rated nominal voltage with the inverter supplied with its nominal value of DC input voltage.		P
	Compliance is checked by measuring the AC output voltage with the inverter supplying no load, and again with the inverter supplying a resistive load equal to the inverters rated maximum continuous output power in stand-alone mode. The AC output voltage is measured after any transient effects from the application or removal of the load have ceased.		P
4.7.4.3	Steady state output voltage across the DC input range	See appended table.	P
	The steady-state AC output voltage shall not be less than 85 % or more than 110 % of the rated nominal voltage with the inverter supplied with any value within the rated range of DC input voltage.		P
	Compliance is checked by measuring the AC output voltage under four sets of conditions: with the inverter supplying no load and supplying a resistive load equal to the inverters rated maximum continuous output power in stand-alone mode, both		P

IEC/EN 62109-2			
Clause	Requirement – Test	Result - Remark	Verdict
	at the minimum rated DC input voltage and at the maximum rated DC input voltage. The AC output voltage is measured after any transient effects from the application or removal of the load have ceased.		
4.7.4.4	Load step response of the output voltage at nominal DC input	See appended table.	P
	The AC output voltage shall not be less than 85 % or more than 110 % of the rated nominal voltage for more than 1,5 s after application or removal of a resistive load equal to the inverter's rated maximum continuous output power in stand-alone mode, with the inverter supplied with its nominal value of DC input voltage.		P
	Compliance is checked by measuring the AC output voltage after a resistive load step from no load to full rated maximum continuous output power, and from full power to no load. The RMS output voltage of the first complete cycle coming after $t = 1,5$ s is to be measured, where t is the time measured from the application of the load step change.		P
4.7.4.5	Steady state output frequency	See appended table.	P
	The steady-state AC output frequency shall not vary from the nominal value by more than +4 % or -6 %.		P
	Compliance is checked by measuring the AC output frequency under four sets of conditions: with the inverter supplying no load and supplying a resistive load equal to the inverters rated maximum continuous output power in stand-alone mode, at both the minimum rated DC input voltage and at the maximum rated DC input voltage. The AC output frequency is measured after any transient effects from the application or removal of the load have ceased.		P
4.7.5	Stand-alone inverter output voltage waveform		P
4.7.5.1	General		P
4.7.5.2	Sinusoidal output voltage waveform requirements	See appended table.	P
4.7.5.3	Non-sinusoidal output waveform requirements		N/A
4.7.5.3.1	General		N/A
4.7.5.3.2	Total harmonic distortion		N/A
4.7.5.3.3	Waveform slope		N/A
4.7.5.3.4	Peak voltage		N/A
4.7.5.4	Information requirements for non-sinusoidal waveforms		N/A
4.7.5.5	Output voltage waveform requirements for inverters for dedicated loads		N/A
4.8	Additional tests for grid-interactive inverters		N/A

IEC/EN 62109-2			
Clause	Requirement – Test	Result - Remark	Verdict
4.8.1	General requirements regarding inverter isolation and array grounding		N/A
	Inverters may or may not provide galvanic isolation from the MAINS to the PV array, and the array may or may not have one side of the circuit grounded. Inverters shall comply with the requirements in Table 4-201 for the applicable combination of inverter isolation and array grounding.		N/A
4.8.2	Array insulation resistance detection for inverters for ungrounded and functionally grounded arrays		N/A
4.8.2.1	Array insulation resistance detection for inverters for ungrounded arrays		N/A
	Inverters for use with ungrounded arrays shall have means to measure the DC insulation resistance from the PV input (array) to ground before starting operation, or shall be provided with installation instructions in accordance with 5.3.2.11.		N/A
	If the insulation resistance is less than $R = (V_{MAX} PV/30 \text{ mA})$ ohms, the inverter:		N/A
	– for isolated inverters, shall indicate a fault in accordance with 13.9 (operation is allowed); the fault indication shall be maintained until the array insulation resistance has recovered to a value higher than the limit above;		N/A
	– for non-isolated inverters, or inverters with isolation not complying with the leakage current limits in the minimum inverter isolation requirements in Table 30, shall indicate a fault in accordance with 13.9, and shall not connect to the mains; the inverter may continue to make the measurement, may stop indicating a fault and may connect to the mains if the array insulation resistance has recovered to a value higher than the limit above.		N/A
	Compliance is checked by analysis of the design and by testing, as follows:		N/A
	The inverter shall be connected to PV and AC sources as specified in the reference test conditions in Part 1, except with the PV voltage set below the minimum operating voltage required for the inverter to attempt to start operating. A resistance 10 % less than the limit above shall be connected between ground and each PV input terminal of the inverter, in turn, and then the PV input voltage shall be raised to a value high enough that the inverter attempts to begin operation. The inverter shall indicate a fault in accordance with 13.9 and take the action (operating or not operating as applicable) required above.		N/A
	It is not required to test all PV input terminals if analysis of the design indicates that one or more		N/A

IEC/EN 62109-2			
Clause	Requirement – Test	Result - Remark	Verdict
	terminals can be expected to have the same result, for example where multiple PV string inputs are in parallel.		
4.8.2.2	Array insulation resistance detection for inverters for functionally grounded arrays		N/A
	Inverters that functionally ground the array through an intentional resistance integral to the inverter, shall meet the requirements in a) and c), or b) and c) below:		N/A
	a) The value of the total resistance, including the intentional resistance for array functional grounding, the expected insulation resistance of the array to ground, and the resistance of any other networks connected to ground (for example measurement networks) must not be lower than $R = (V_{MAX} PV/30 \text{ mA})$ ohms. The expected insulation resistance of the array to ground shall be calculated based on an array insulation resistance of 40 MΩ per m ² , with the surface area of the panels either known, or calculated based on the inverter power rating and the efficiency of the worst-case panels that the inverter is designed to be used with.		N/A
	b) As an alternative to a), or if a resistor value lower than in a) is used, the inverter shall incorporate means to detect, during operation, if the total current through the resistor and any networks (for example measurement networks) in parallel with it, exceeds the residual current values and times in Table 31 and shall either disconnect the resistor or limit the current by other means. If the inverter is a non-isolated inverter, or has isolation not complying with the leakage current limits in the minimum inverter isolation requirements in Table 30, it shall also disconnect from the mains.		N/A
	c) The inverter shall have means to measure the DC insulation resistance from the PV input to ground before starting operation, in accordance with 4.8.2.1.		N/A
4.8.3	Array residual current detection		N/A
4.8.3.1	Ungrounded arrays operating at DVC-B and DVC-C voltages can create a shock hazard if live parts are contacted and a return path for touch current exists. In a non-isolated inverter, or an inverter with isolation that does not adequately limit the available touch current, the connection of the mains to earth (i.e. the earthed neutral) provides a return path for touch current if personnel inadvertently contact live parts of the array and earth at the same time. The requirements in this section provide additional protection against this shock hazard through the application of residual current detectors (RCD's) per		N/A

IEC/EN 62109-2			
Clause	Requirement – Test	Result - Remark	Verdict
	4.8.3.4 or by monitoring for sudden changes in residual current per 4.8.3.5, except neither is required in an isolated inverter where the isolation provided limits the available touch current to less than 30 mA when tested in accordance with 4.8.3.2.		
	Ungrounded and grounded arrays can create a fire hazard if a ground fault occurs that allows excessive current to flow on conductive parts or structures that are not intended to carry current. The requirements in this section provide additional protection against this fire hazard by application of RCD's per 4.8.3.4 or by monitoring for continuous excessive residual current per 4.8.3.5, except neither is required in an isolated inverter where the isolation provided limits the available current to less than:		N/A
	– 300 mA RMS for inverters with rated continuous output power \leq 30 kVA, or		N/A
	– 10 mA RMS per kVA of rated continuous output power for inverters with rated continuous output power rating > 30 kVA.		N/A
4.8.3.2	30 mA touch current type test for isolated inverters		N/A
	Compliance with the 30 mA limit in 4.8.3.1 is tested with the inverter connected and operating under reference test conditions, except that the DC supply to the inverter must not have any connection to earth, and the mains supply to the inverter must have one pole earthed. It is acceptable (and may be necessary) to defeat array insulation resistance detection functions during this test. The touch current measurement circuit of IEC 60990, Figure 4 is connected from each terminal of the array to ground, one at a time. The resulting touch current is recorded and compared to the 30 mA limit, to determine the requirements for array ground insulation resistance and array residual current detection in Table 30.		N/A
4.8.3.3	Fire hazard residual current type test for isolated inverters		N/A
	Compliance with the 300 mA or 10 mA per kVA limit in 4.8.3.1 is tested with the inverter connected and operating under reference test conditions, except that the DC supply to the inverter must not have any connection to earth, and the mains supply to the inverter must have one pole earthed. It is acceptable (and may be necessary) to defeat array insulation resistance detection functions during this test. An ammeter is connected from each PV input terminal of the inverter to ground, one at a time. The ammeter used shall be an RMS meter that		N/A

IEC/EN 62109-2			
Clause	Requirement – Test	Result - Remark	Verdict
	responds to both the AC and DC components of the current, with a bandwidth of at least 2 kHz. The current is recorded and compared to the limit in 4.8.3.1, to determine the requirements for array ground insulation resistance and array residual current detection in Table 30.		
4.8.3.4	Protection by application of RCD's		N/A
	The requirement for additional protection in 4.8.3.1 can be met by provision of an RCD with a residual current setting of 30 mA, located between the inverter and the mains. The selection of the RCD type to ensure compatibility with the inverter must be made according to rules for RCD selection in Part 1. The RCD may be provided integral to the inverter, or may be provided by the installer if details of the rating, type, and location for the RCD are given in the installation instructions per 5.3.2.9.		N/A
4.8.3.5	Protection by residual current monitoring		N/A
4.8.3.5.1	General		N/A
	Where required by Table 30, the inverter shall provide residual current monitoring that functions whenever the inverter is connected to the mains with the automatic disconnection means closed. The residual current monitoring means shall measure the total (both a.c. and d.c. components) RMS current.		N/A
	As indicated in Table 30 for different inverter types, array types, and inverter isolation levels, detection may be required for excessive continuous residual current, excessive sudden changes in residual current, or both, according to the following limits:		N/A
	a) Continuous residual current: The inverter shall disconnect within 0,3 s and indicate a fault in accordance with 13.9 if the continuous residual current exceeds: – maximum 300 mA for inverters with continuous output power rating \leq 30 kVA; – maximum 10 mA per kVA of rated continuous output power for inverters with continuous output power rating $>$ 30 kVA.		N/A
	b) Sudden changes in residual current: The inverter shall disconnect from the mains within the time specified in Table 31 and indicate a fault in accordance with 13.9, if a sudden increase in the RMS residual current is detected exceeding the value in the table.		N/A
	Exceptions: - monitoring for the continuous condition in a) is not required for an inverter with isolation complying with		N/A

IEC/EN 62109-2			
Clause	Requirement – Test	Result - Remark	Verdict
	4.201.3.1.2 - monitoring for the sudden changes in b) is not required for an inverter with isolation complying with 4.201.3.1.1		
4.8.3.5.2	Test for detection of excessive continuous residual current		N/A
	An external adjustable resistance is connected from ground to one PV input terminal of the inverter. The resistance shall be steadily lowered in an attempt to exceed the residual current limit in a) above, until the inverter disconnects. This determines the actual trip level of the sample under test, which shall be less than or equal to the continuous residual current limit above. To test the trip time, the test resistance is then adjusted to set the residual current to a value approximately 10 mA below the actual trip level. A second external resistance, adjusted to cause approximately 20 mA of residual current to flow, is connected through a switch from ground to the same PV input terminal as the first resistance. The switch is closed, increasing the residual current to a level above the trip level determined above. The time shall be measured from the moment the second resistance is connected until the moment the inverter disconnects from the mains, as determined by observing the inverter output current and measuring the time until the current drops to zero. This test shall be repeated 5 times, and for all 5 tests the time to disconnect shall not exceed 0,3 s.		N/A
4.8.3.5.3	Test for detection of sudden changes in residual current		N/A
	a) Setting the pre-existing baseline level of continuous residual current: An adjustable capacitance is connected to one PV terminal. This capacitance is slowly increased until the inverter disconnects by means of the continuous residual current detection function. The capacitance is then lowered such that the continuous residual current is reduced below that disconnection level, by an amount equal to approximately 150 % of the first residual current sudden change value in 4.8.3.5.1 b) to be tested (e.g. 45 mA for the 30 mA test) and the inverter is re-started.		N/A
	b) Applying the sudden change in residual current: An external resistance, pre-adjusted to cause 30 mA of residual current to flow, is connected through a switch from ground to the same PV input terminal as the capacitance in step a) above. The time shall be measured from the moment the switch is closed (i.e. connecting the resistance and applying the residual current sudden change) until the moment		N/A

IEC/EN 62109-2			
Clause	Requirement – Test	Result - Remark	Verdict
	the inverter disconnects from the grid, as determined by observing the inverter output current and measuring the time until the current drops to zero. This test shall be repeated 5 times, and all 5 results shall not exceed the time limit indicated in the 30 mA row of Table 31.		
	The above set of tests shall then be repeated for each PV terminal. It is not required to test all PV input terminals if analysis of the design indicates that one or more terminals can be expected to have the same result, for example where multiple PV string inputs are in parallel.		N/A
	If the inverter topology is such that the AC component of the voltage on the PV terminals is very small, a very large amount of capacitance may be needed to perform step a) of this test. In this case it is allowable to use resistance in place of or in addition to the capacitance to achieve the required amount of residual current. This method may not be used on inverter topologies that result in an AC component on the PV terminals that is equal to or greater than the RMS value of the half- wave rectified mains voltage.		N/A
4.8.3.6	Systems located in closed electrical operating areas		N/A
	For systems in which the inverter and a DVC-B or DVC-C PV array are located in closed electrical operating areas, the protection against shock hazard on the PV array in sub-clauses 4.8.2.1, 4.8.2.2, 4.8.3.2, 4.8.3.4, and 4.8.3.5.1 b) is not required if the installation information provided with the inverter indicates the restriction for use in a closed electrical operating area, and indicates what forms of shock hazard protection are and are not provided integral to the inverter, in accordance with 5.3.2.7. The inverter shall be marked as in 5.2.2.6.		N/A

5	Marking and documentation		P
5.1	Marking		P
5.1.4	Equipment ratings		P
	In addition to the markings required in other clauses of Part 1 and elsewhere in this Part 2, the ratings in Table 32 shall be plainly and permanently marked on the inverter, where it is readily visible after installation. Only those ratings that are applicable based on the type of inverter are required.		P
	An inverter that is adjustable for more than one nominal output voltage shall be marked to indicate the particular voltage for which it is set when shipped from the factory. It is acceptable for this marking to be in the form of a removable tag or		P

IEC/EN 62109-2			
Clause	Requirement – Test	Result - Remark	Verdict
	other non-permanent method		
5.2	Warning markings		P
5.2.2	Content for warning markings		P
5.2.2.6	Inverters for closed electrical operating areas		N/A
	Where required by 4.8.3.6, an inverter not provided with full protection against shock hazard on the PV array shall be marked with a warning that the inverter is only for use in a closed electrical operating area, and referring to the installation instructions.		N/A
5.3	Documentation		P
5.3.2	Information related to installation		P
5.3.2.1	Ratings		P
	Subclause 5.3.2 of Part 1 requires the documentation to include ratings information for each input and output. For inverters this information shall be as in Table 33 below. Only those ratings that are applicable based on the type of inverter are required.		P
5.3.2.2	Grid-interactive inverter set points		N/A
	For a grid-interactive unit with field adjustable trip points, trip times, or reconnect times, the presence of such controls, the means for adjustment, the factory default values, and the limits of the ranges of adjustability shall be provided in the documentation for the PCE or in other format such as on a website.		N/A
	The setpoints of field adjustable setpoints shall be accessible from the PCE, for example on a display panel, user interface, or communications port.		N/A
5.3.2.3	Transformers and isolation		P
	An inverter shall be provided with information to the installer regarding whether an internal isolation transformer is provided, and if so, what level of insulation (functional, basic, reinforced, or double) is provided by that transformer. The instructions shall also indicate what the resulting installation requirements are regarding such things as earthing or not earthing the array, providing external residual current detection devices, requiring an external isolation transformer, etc.		P
5.3.2.4	Transformers required but not provided		N/A
	An inverter that requires an external isolation transformer not provided with the unit, shall be provided with instructions that specify the configuration type, electrical ratings, and environmental ratings for the external isolation transformer with which it is intended to be used.		N/A

IEC/EN 62109-2			
Clause	Requirement – Test	Result - Remark	Verdict
5.3.2.5	PV modules for non-isolated inverters		N/A
	Non-isolated inverters shall be provided with installation instructions that require PV modules that have an IEC 61730 Class A rating. If the maximum AC mains operating voltage is higher than the PV array maximum system voltage then the instructions shall require PV modules that have a maximum system voltage rating based upon the AC mains voltage.		N/A
5.3.2.6	Non-sinusoidal output waveform information		N/A
	The instruction manual for a stand-alone inverter not complying with 4.7.5.2 shall include a warning that the waveform is not sinusoidal, that some loads may experience increased heating, and that the user should consult the manufacturers of the intended load equipment before operating that load with the inverter. The inverter manufacturer shall provide information regarding what types of loads may experience increased heating, recommendations for maximum operating times with such loads, and shall specify the THD, slope, and peak voltage of the waveforms as determined by the testing in 4.7.5.3.2 through 4.7.5.3.4.		N/A
5.3.2.7	Systems located in closed electrical operating areas		N/A
	Where required by 4.8.3.6, an inverter not provided with full protection against shock hazard on the PV array shall be provided with installation instructions requiring that the inverter and the array must be installed in closed electrical operating areas, and indicating which forms of shock hazard protection are and are not provided integral to the inverter (for example the RCD, isolation transformer complying with the 30 mA touch current limit, or residual current monitoring for sudden changes).		N/A
5.3.2.8	Stand-alone inverter output circuit bonding		P
	Where required by 7.3.10, the documentation for an inverter shall include the following:		P
	– if output circuit bonding is required but is not provided integral to the inverter, the required means shall be described in the installation instructions, including which conductor is to be bonded and the required current carrying capability or cross-section of the bonding means; – if the output circuit is intended to be floating, the documentation for the inverter shall indicate that the output is floating.		P
5.3.2.9	Protection by application of RCD's		N/A
	Where the requirement for additional protection in 4.8.3.1 is met by requiring an RCD that is not		N/A

IEC/EN 62109-2			
Clause	Requirement – Test	Result - Remark	Verdict
	provided integral to the inverter, as allowed by 4.8.3.4, the installation instructions shall state the need for the RCD, and shall specify its rating, type, and required circuit location.		
5.3.2.10	Remote indication of faults		N/A
	The installation instructions shall include an explanation of how to properly make connections to (where applicable), and use, the electrical or electronic fault indication required by 13.9.		N/A
5.3.2.11	External array insulation resistance measurement and response		N/A
	The installation instructions for an inverter for use with ungrounded arrays that does not incorporate all the aspects of the insulation resistance measurement and response requirements in 4.8.2.1, must include:		N/A
	– for isolated inverters, an explanation of what aspects of array insulation resistance measurement and response are not provided, and an instruction to consult local regulations to determine if any additional functions are required or not;		N/A
	– for non-isolated inverters: <ul style="list-style-type: none"> • an explanation of what external equipment must be provided in the system, and • what the setpoints and response implemented by that equipment must be, and • how that equipment is to be interfaced with the rest of the system. 		N/A
5.3.2.12	Array functional grounding information		N/A
	Where approach a) of 4.8.2.2 is used, the installation instructions for the inverter shall include all of the following:		N/A
	a) the value of the total resistance between the PV circuit and ground integral to the inverter;		N/A
	b) the minimum array insulation resistance to ground that system designer or installer must meet when selecting the PV panel and system design, based on the minimum value that the design of the PV functional grounding in the inverter was based on;		N/A
	c) the minimum value of the total resistance $R = V_{MAX} PV/30 \text{ mA}$ that the system must meet, with an explanation of how to calculate the total;		N/A
	d) a warning that there is a risk of shock hazard if the total minimum resistance requirement is not met.		N/A
5.3.2.13	Stand-alone inverters for dedicated loads		N/A

IEC/EN 62109-2			
Clause	Requirement – Test	Result - Remark	Verdict
	Where the approach of 4.7.5.5 is used, the installation instructions for the inverter shall include a warning that the inverter is only to be used with the dedicated load for which it was evaluated, and shall specify the dedicated load.		N/A
5.3.2.14	Identification of firmware version(s)		N/A
6	Environmental requirements and conditions		P
	This clause of Part 1 is applicable.		P
7	Protection against electric shock and energy hazards		P
7.3	Protection against electric shock		P
7.3.10	Additional requirements for stand-alone inverters	Connected to permanent grounded-wiring system	P
	Depending on the supply earthing system that a stand-alone inverter is intended to be used with or to create, the output circuit may be required to have one circuit conductor bonded to earth to create a grounded conductor and an earthed system.		P
7.3.11	Functionally grounded arrays		N/A
	All PV conductors in a functionally grounded array shall be treated as being live parts with respect to protection against electric shock.		N/A
8	Protection against mechanical hazards		P
	This clause of Part 1 is applicable.		P
9	Protection against fire hazard		P
	This clause of Part 1 is applicable with the following exceptions:		---
9.3	Short-circuit and overcurrent protection		P
9.3.4	Inverter backfeed current onto the array		P
	The backfeed current testing and documentation requirements in Part 1 apply, including but not limited to the following.		P
	Testing shall be performed to determine the current that can flow out of the inverter PV input terminals with a fault applied on inverter or on the PV input wiring. Faults to be considered include shorting all or part of the array, and any faults in the inverter that would allow energy from another source (for example the mains or a battery) to impress currents on the PV array wiring. The current measurement is not required to include		P

IEC/EN 62109-2			
Clause	Requirement – Test	Result - Remark	Verdict
	any current transients that result from applying the short circuit, if such transients result from discharging storage elements other than batteries.		
	This inverter backfeed current value shall be provided in the installation instructions regardless of the value of the current, in accordance with Table 33.....		P
10	Protection against sonic pressure hazards		N/A
	This clause of Part 1 is applicable.	No such hazards	N/A
11	Protection against liquid hazards		N/A
	This clause of Part 1 is applicable.	No such hazards	N/A
12	Protection against chemical hazards		N/A
	This clause of Part 1 is applicable.	No such hazards	N/A
13	Physical requirements		P
13.9	Fault indication		P
	Where this Part 2 requires the inverter to indicate a fault, both of the following shall be provided: a) a visible or audible indication, integral to the inverter, and detectable from outside the inverter, and b) an electrical or electronic indication that can be remotely accessed and used.	LCD display and LED indicator	P
	The installation instructions shall include information regarding how to properly make connections (where applicable) and use the electrical or electronic means in b) above, in accordance with 5.3.2.10.	Instructed in the User Manual	P
14	Components		P
	This clause of Part 1 is applicable.	See EN 62109-1 test report for detail	P

4.4.4	TABLE: Single fault condition to be applied						N/A
	Ambient temperature (°C)					---	---
	Power source for EUT: Manufacturer, model/type, output rating					---	---
4.4.4.15.1	Fault-tolerance of residual current monitoring						
Component No.	Fault	Supply voltage (V)	Test time	Fuse #	Fuse current (A)	Observation	
---	---	---	---	---	---	---	
---	---	---	---	---	---	---	
---	---	---	---	---	---	---	
Check that the residual current monitoring operates properly							
Supplementary information:							

4.4.4	TABLE: Single fault condition to be applied						N/A
	Ambient temperature (°C)					---	---
	Power source for EUT: Manufacturer, model/type, output rating					---	---
4.4.4.15.2	Fault-tolerance of automatic disconnecting means						
Component No.	Fault	Supply voltage (V)	Test time	Fuse #	Fuse current (A)	Observation	
---	---	---	---	---	---	---	
---	---	---	---	---	---	---	
---	---	---	---	---	---	---	
Check that the relays fulfil the basic insulation or simple separation based on the PV circuit working voltage.						---	
Each active phase can be switched. (L and N)						---	
Supplementary information:							

4.4.4.17	Cooling system failure – Blanketing test		P
	Test voltage (Vdc)..... :	450	---
	Test current (Idc)	--	---
	Test voltage (Vac)..... :	207	---
	Test current (Iac)	--	---
	t _{amb1} (°C)	50.0	---
	t _{amb2} (°C)	50.0	---
maximum temperature T of part/at:		T (°C)	T _{max} (°C)
Enclosure		55.2	90
Supplementary information:			

4.7.4	TABLE: mains supply electrical data in normal condition						P
Model	U (V) DC	I (A) DC	P (W) DC	P (kW) AC	I(A) AC	U (V) AC/F(Hz) (off-grid port)	
AXPERT WP 8KW TWIN	90Vdc	0	0	No load	0	229.8/50	
	450Vdc	2.44	1100	No load	0	229.8/50	
	90Vdc	0	0	Full load	0	229.8/50	
	450Vdc	19.21	8643	Full load	34.92	229.8/50	
	450Vdc	--	--	0-100%	--	229.8/50	
	450Vdc	--	--	100%-0	--	229.8/50	
Supplementary information: The minimum input voltage is 130V to work normally on Solar Charge mode.							

4.7.5.2	TABLE: Harmonics and inter-harmonics (u)			P
Harmon. Nr.(U)	P/Prated			Limit
	5%	50%	100%	
2	0.14%	0.13%	0.11%	6%
3	0.26%	1.20%	2.36%	6%
4	0.06%	0.05%	0.18%	6%
5	2.02%	1.05%	1.92%	6%
6	0.05	0.05%	0.16%	6%
7	1.03%	1.49%	1.17%	6%
8	0.06%	0.08%	0.10%	6%
9	0.40%	0.80%	1.13%	6%
10	0.60	0.06%	0.11%	6%
11	0.74%	0.07%	0.33%	6%
12	0.05%	0.05%	0.06%	6%
13	0.28%	0.52%	1.13%	6%
14	0.06%	0.06%	0.06%	6%
15	0.20%	0.51%	0.50%	6%
16	0.09%	0.05%	0.06%	6%
17	0.37%	0.25%	0.53%	6%
18	0.07%	0.06%	0.05%	6%
19	0.22%	0.08%	0.49%	6%
20	0.08%	0.06%	0.07%	6%
21	0.24%	0.33%	0.16%	6%
22	0.09%	0.06%	0.06%	6%
23	0.26%	0.31%	0.36%	6%
24	0.08%	0.05%	0.05%	6%
25	0.13%	0.13%	0.14%	6%
26	0.10%	0.06%	0.04%	6%
27	0.13%	0.19%	0.25%	6%
28	0.09%	0.06%	0.05%	6%
29	0.04%	0.16%	0.21%	6%
30	0.08%	0.06%	0.04%	6%
31	0.04%	0.06%	0.29%	6%
32	0.08%	0.05%	0.02%	6%
33	0.03%	0.05%	0.20%	6%
34	0.05%	0.04%	0.02%	6%

35	0.06%	0.04%	0.20%	6%
36	0.05%	0.05%	0.03%	6%
37	0.05%	0.04%	0.17%	6%
38	0.05%	0.04%	0.03%	6%
39	0.07%	0.05%	0.11%	6%
40	0.04%	0.03%	0.01%	6%
THD(2-40)	1.10%	1.09%	1.66%	10%
Supplementary information:				

4.8.2	TABLE: Array insulation resistance detection for inverters for ungrounded and functionally grounded arrays			N/A
4.8.2.1	Array insulation resistance detection for inverters for ungrounded arrays			N/A
DC Voltage below minimum operating voltage (V)	DC Voltage for inverter begin operation (V)	Resistance between ground and PV input terminal (Ω)	Required Insulation resistance $R = (V_{MAX PV} / 30mA)$ (Ω)	Result
DC+				
---	---	---	---	---
DC-				
---	---	---	---	---
<p>Note:</p> <p>For isolated inverters, shall indicate a fault in accordance with 13.9 (operation is allowed); the fault indication shall be maintained until the array insulation resistance has recovered to a value higher than the limit above</p> <p>For non-isolated inverters, or inverters with isolation not complying with the leakage current limits in the minimum inverter isolation requirements in Table 30, shall indicate a fault in accordance with 13.9, and shall not connect to the mains; the inverter may continue to make the measurement, may stop indicating a fault and may connect to the mains if the array insulation resistance has recovered to a value higher than the limit above.</p> <p>It is not required to test all PV input terminals if analysis of the design indicates that one or more terminals can be expected to have the same result, for example where multiple PV string inputs are in parallel.</p>				
Supplementary information:				

4.8.3.2	TABLE: 30mA touch current type test for isolated inverters		N/A
Condition	Current (mA)	Limit (30mA)	
DC+ to PE	---	---	
DC- to PE	---	---	
Supplementary information:			
The touch current measurement circuit of IEC 60990, Figure 4 is connected from each terminal of the array to ground, one at a time.			

4.8.3.3	TABLE: Fire hazard residual current type test for isolated inverters		N/A
	Condition	Current (mA)	Limit (300mA or 10mA per kVA)
	DC+ to PE	---	---
	DC- to PE	---	---
Supplementary information:			

4.8.3.5	TABLE: Protection by residual current monitoring		N/A
	Test conditions:	Output power (kVA) : Input voltage (V _{DC}): Frequency (Hz) Output AC Voltage (V _{AC}):	
4.8.3.5.2	Test for detection of excessive continuous residual current		N/A
	Fault Current (mA)	Disconnection time (ms)	
	Measured Fault Current Limit 300mA for output power ≤ 30 kVA 10mA per kVA for output power > 30 kVA	Measured Disconnection time	Limit
+ PV to N:			
	---	---	300
- PV to N:			
	---	---	300
Note: – maximum 300mA for inverters with continuous output power rating ≤30 kVA; – maximum 10mA per kVA of rated continuous output power for inverters with continuous output power rating > 30 kVA. This test shall be repeated 5 times, and for all 5 tests the time to disconnect shall not exceed 0,3s. The test is repeated for each PV input terminal. It is not required to test all PV input terminals if analysis of the design indicates that one or more terminals can be expected to have the same result, for example where multiple PV string inputs are in parallel.			
Supplementary information:			

4.8.3.5.3	TABLE: Test for detection of sudden changes in residual current		N/A
+PV to N			
Limit (mA)	U _N	Disconnection time (ms)	Limit (ms)
30		---	300
60		---	150
150		---	40
-PV to N			
Limit (mA)	U _N	Disconnection time (ms)	Limit (ms)
30		---	300
60		---	150
150		---	40

Note:

The capacitive current is risen until disconnection.

Test condition: $I_c + 30/60/150\text{mA} \leq I_{c\text{max}}$. R_1 is set that 30/60/150mA Flow and switch S is closed.

Supplementary information:

Photo Documentation



Fig.1---Over View



Fig. 2---Over View

Photo Documentation

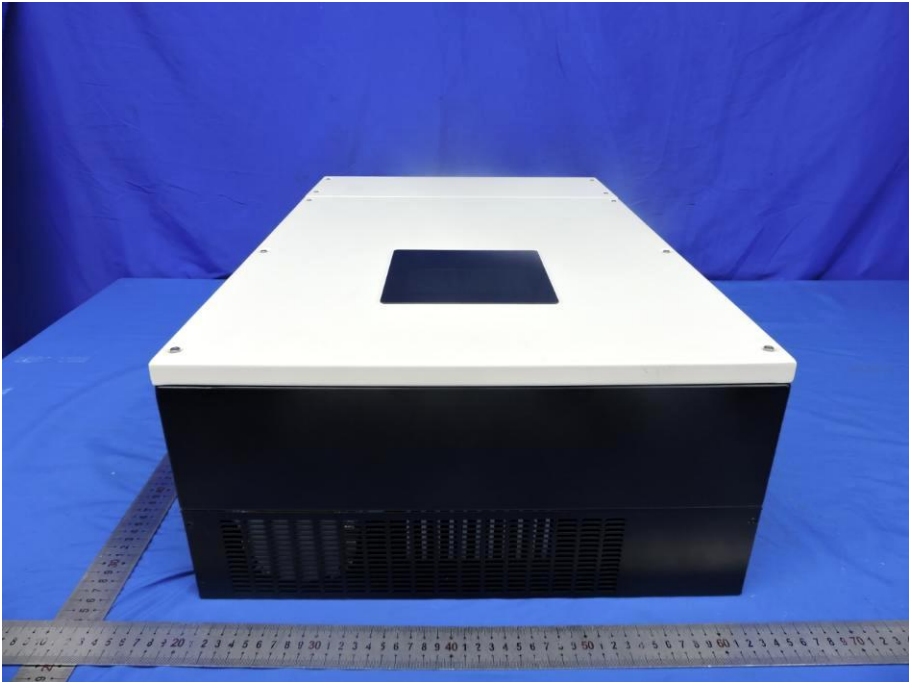

Fig. 3---Over View



Fig. 4---Over View

Photo Documentation



Fig. 5---Internal View



Fig. 6---Internal View

Photo Documentation



Fig. 7---PCB View

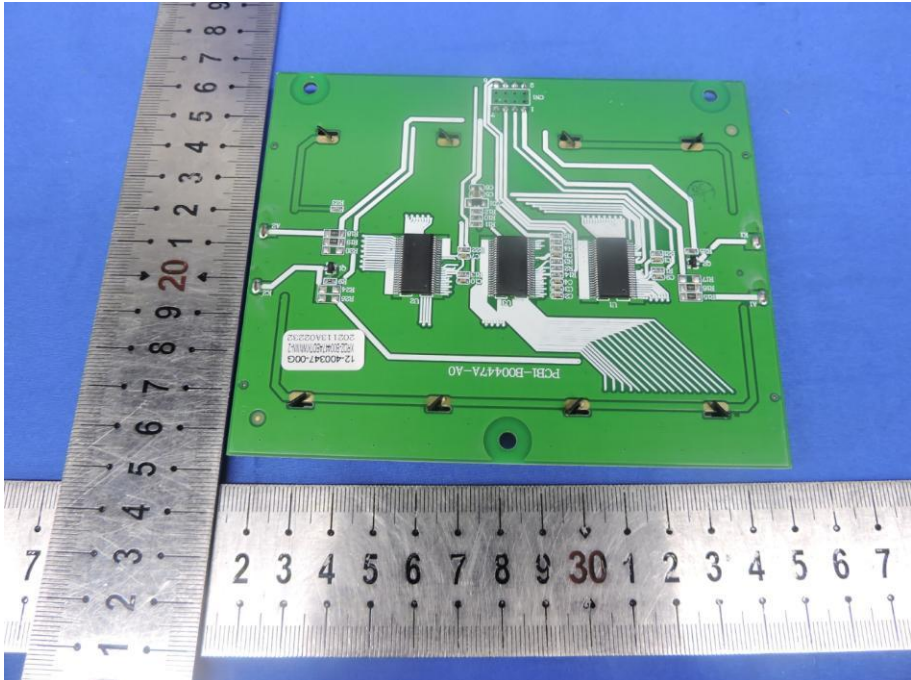

Fig. 8---PCB View

Photo Documentation

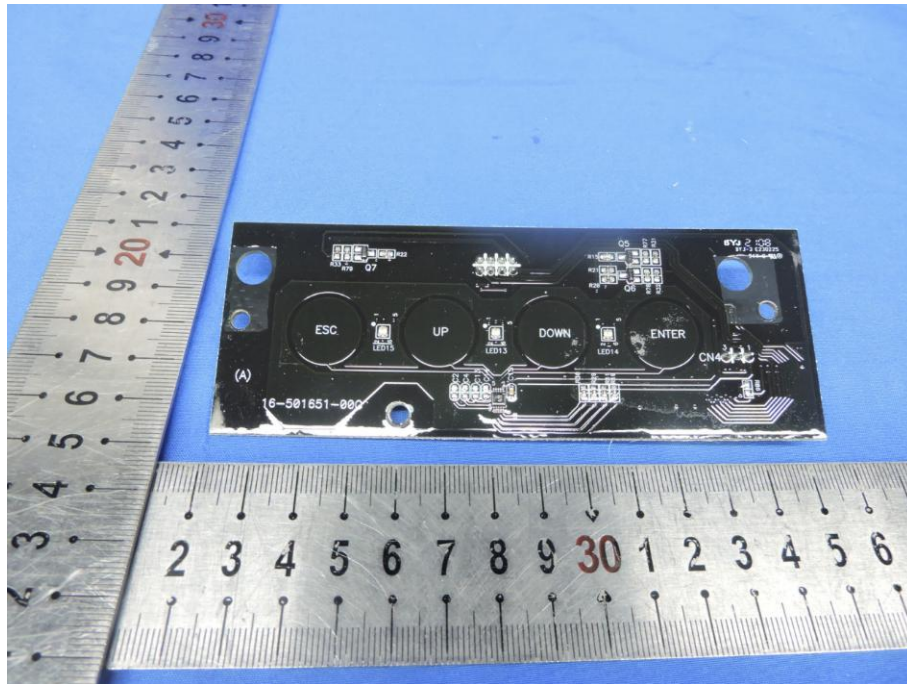

Fig. 9---PCB View

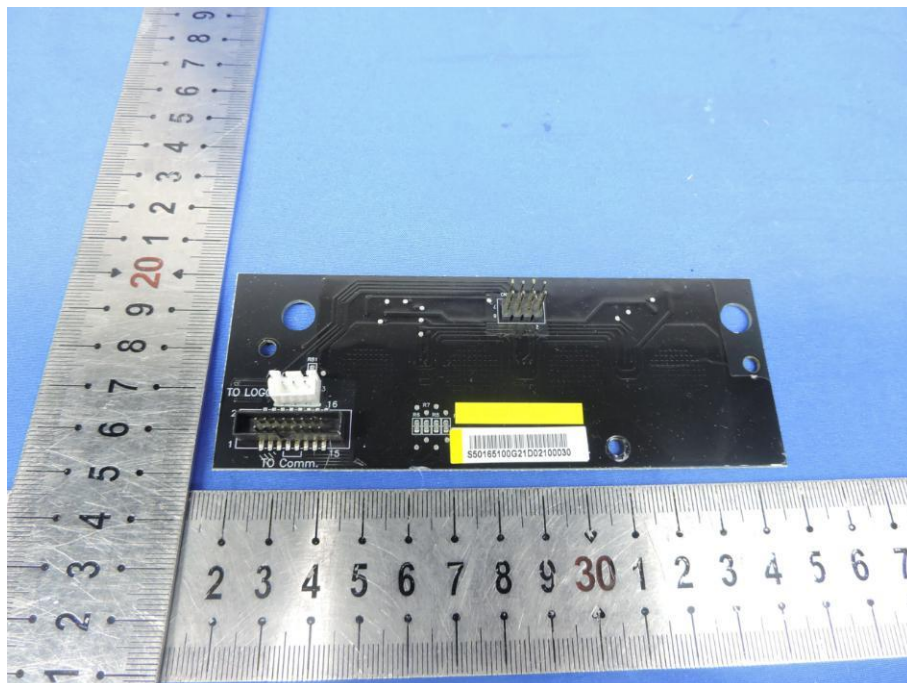

Fig. 10---PCB View

Photo Documentation

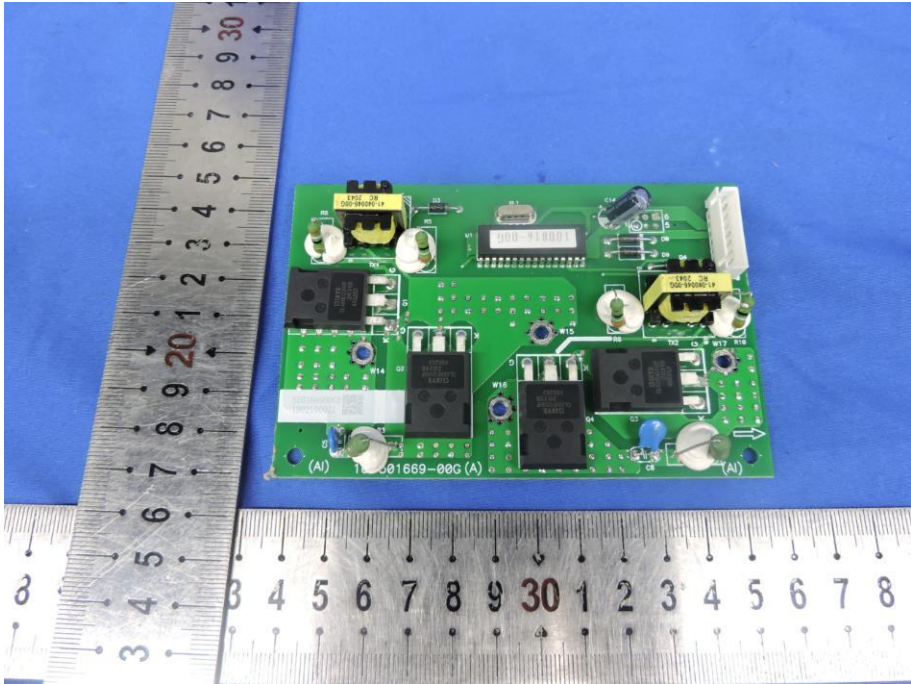

Fig. 11---PCB View

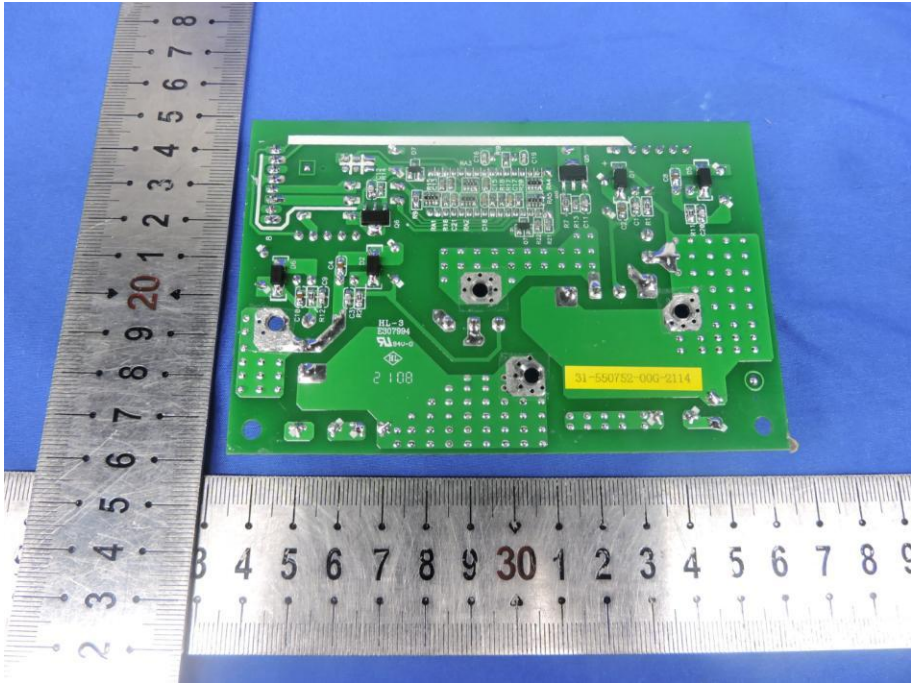

Fig. 12---PCB View

Photo Documentation

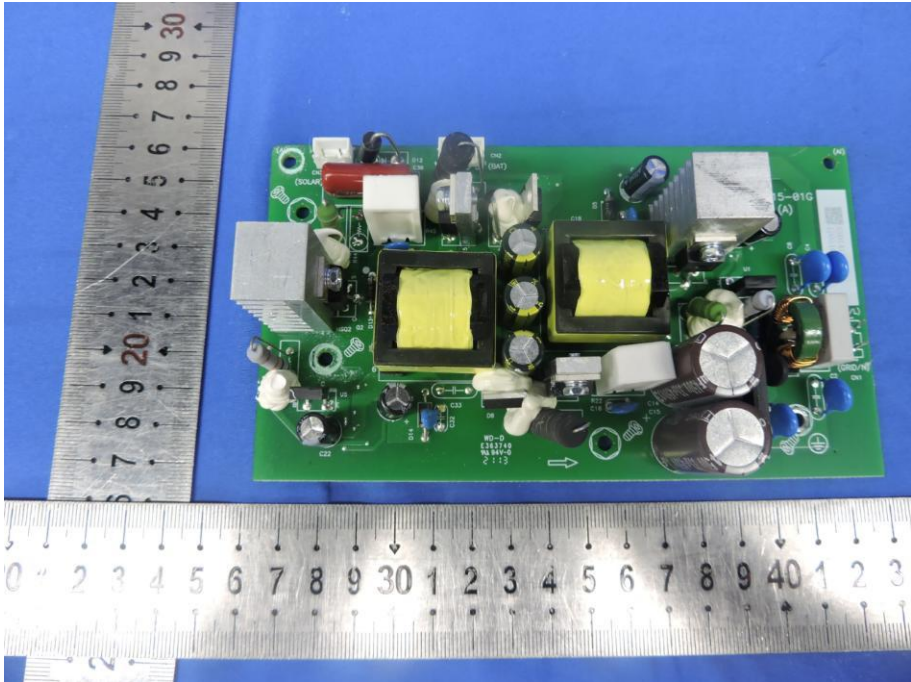

Fig. 13---PCB View

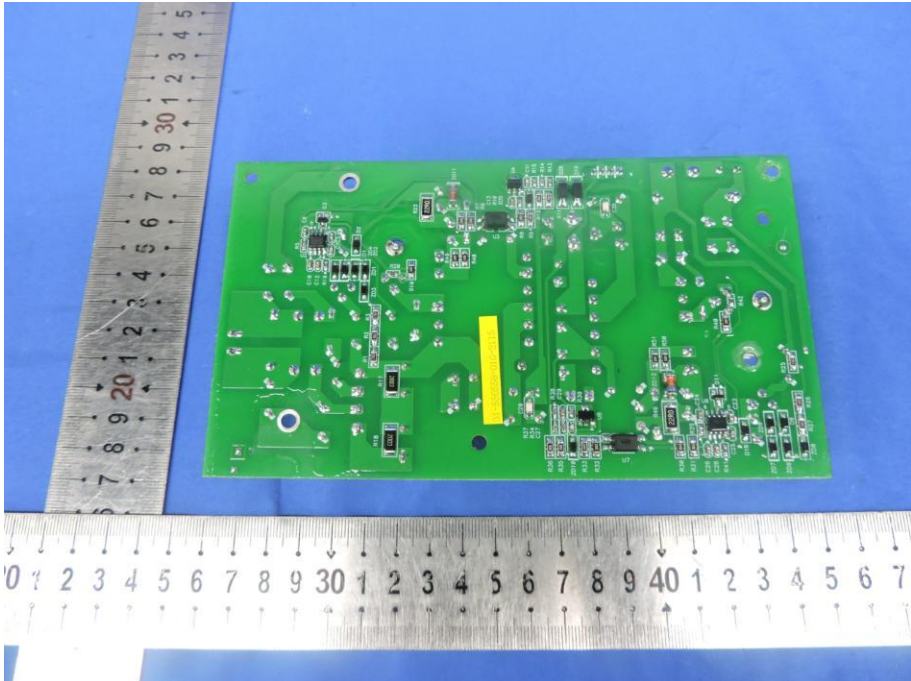

Fig. 14---PCB View

Photo Documentation

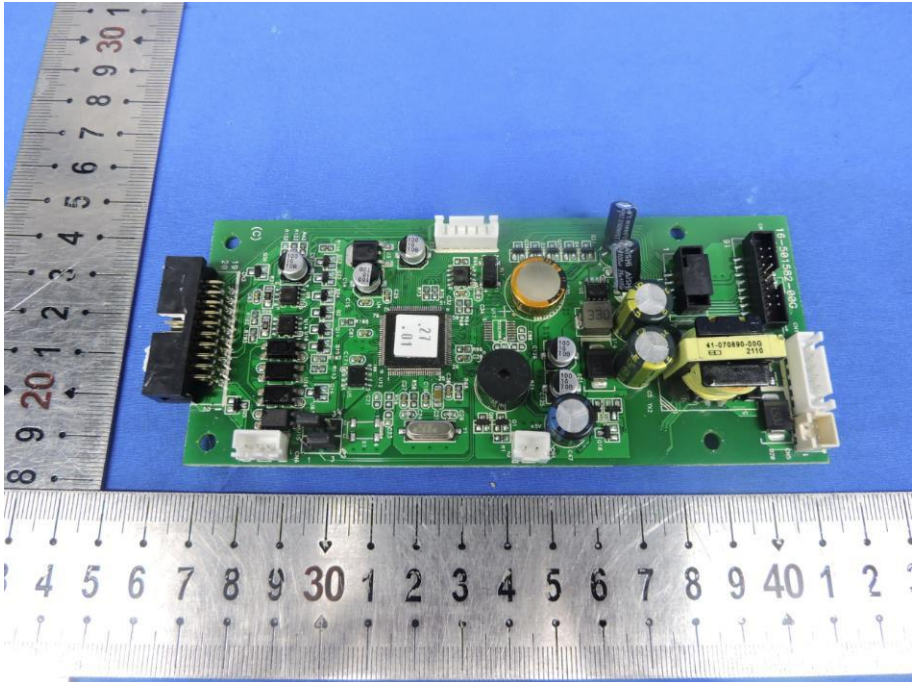

Fig. 15---PCB View

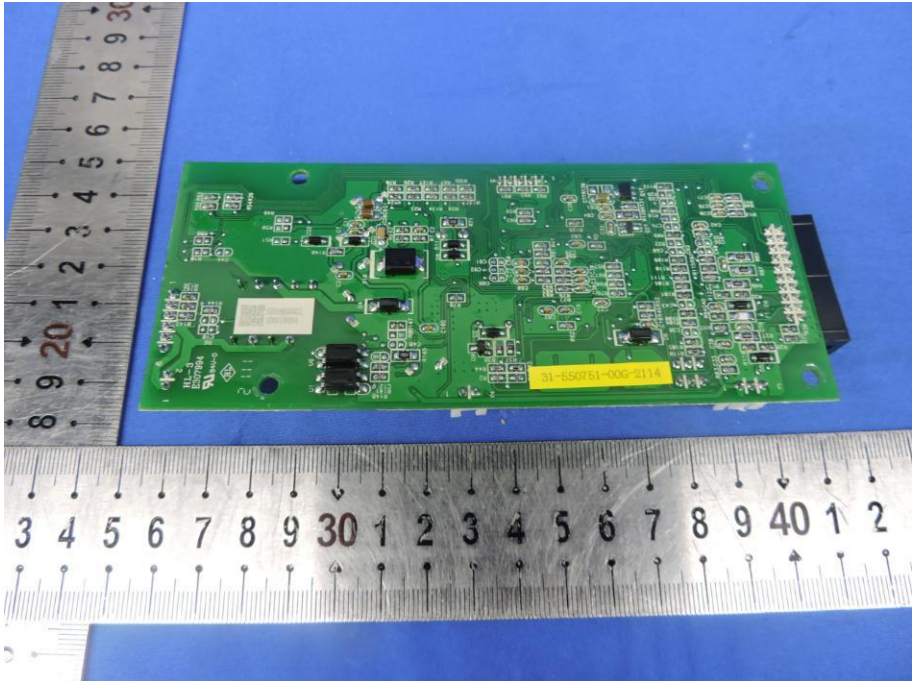

Fig. 16---PCB View

Photo Documentation

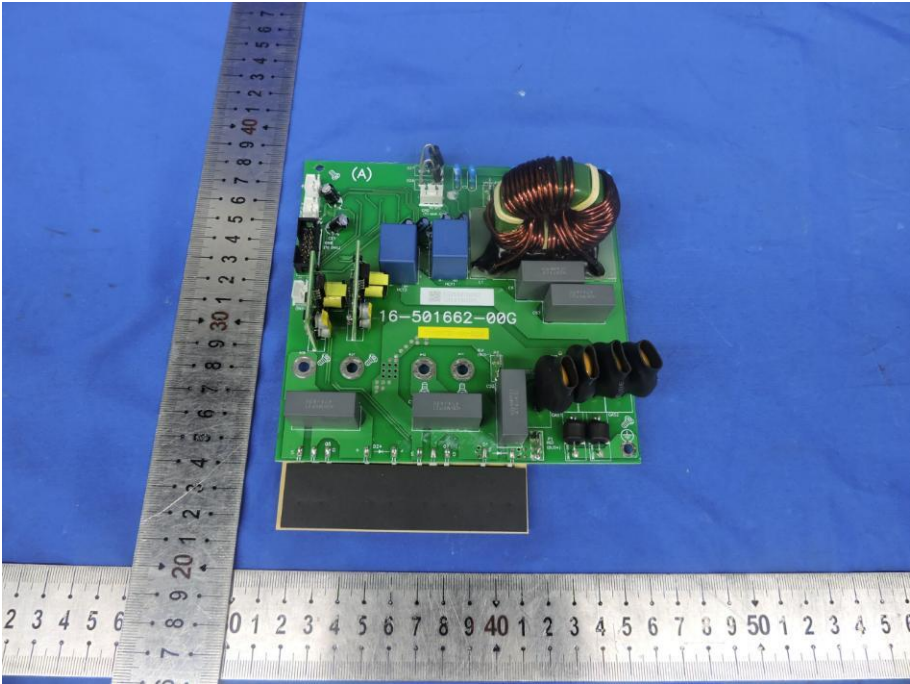

Fig. 17---PCB View

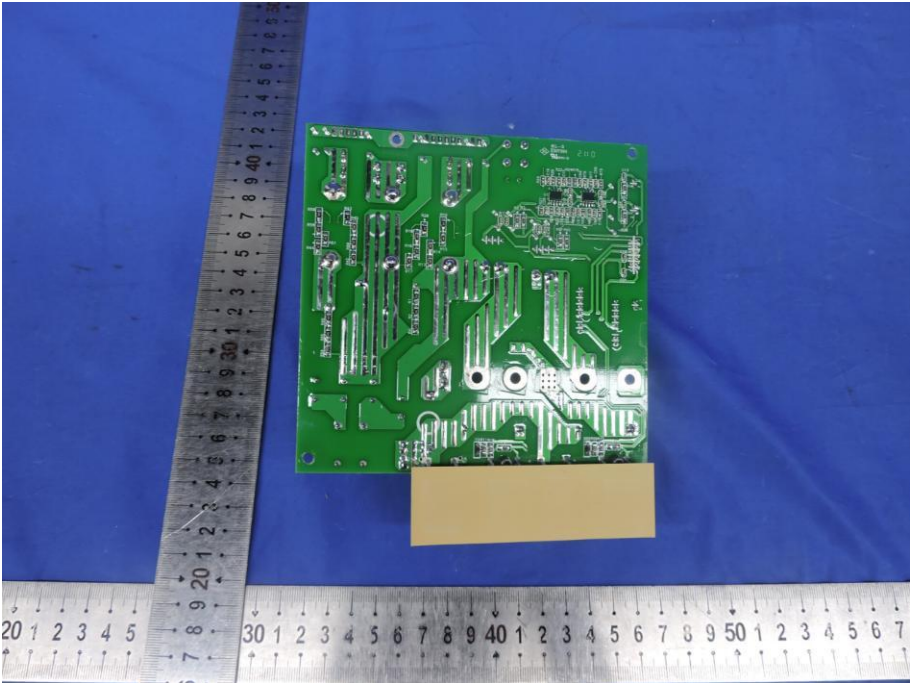

Fig. 18---PCB View

Photo Documentation

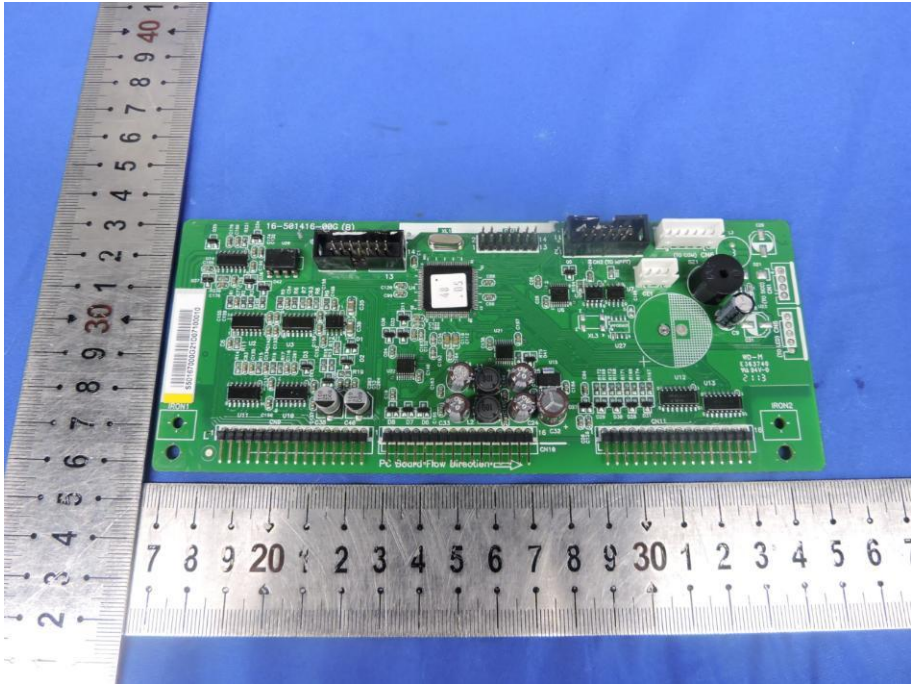

Fig. 19---PCB View



Fig. 20---PCB View

Photo Documentation

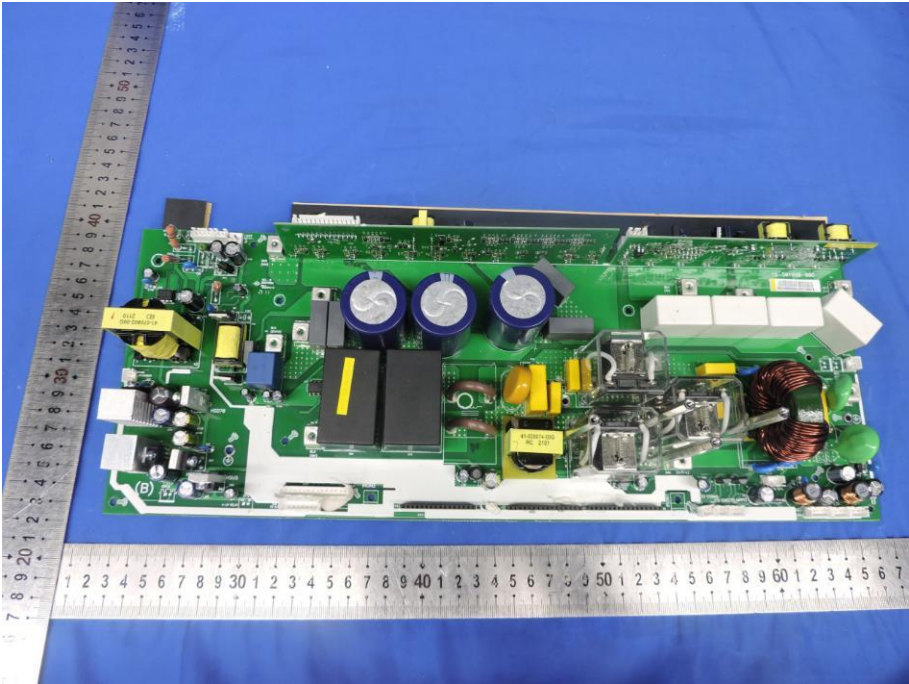

Fig. 21---PCB View

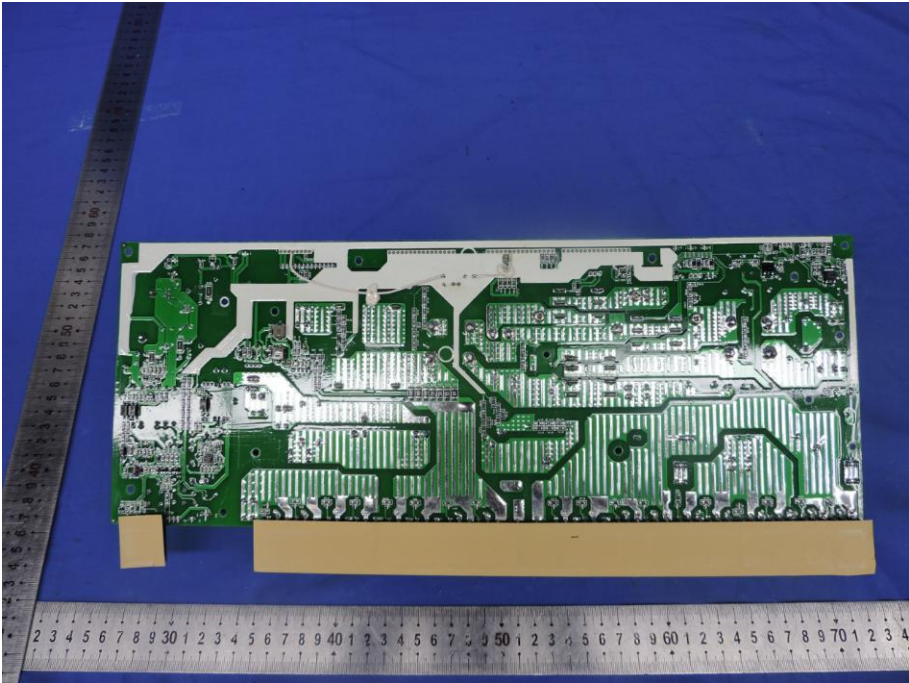

Fig. 22---PCB View

Photo Documentation

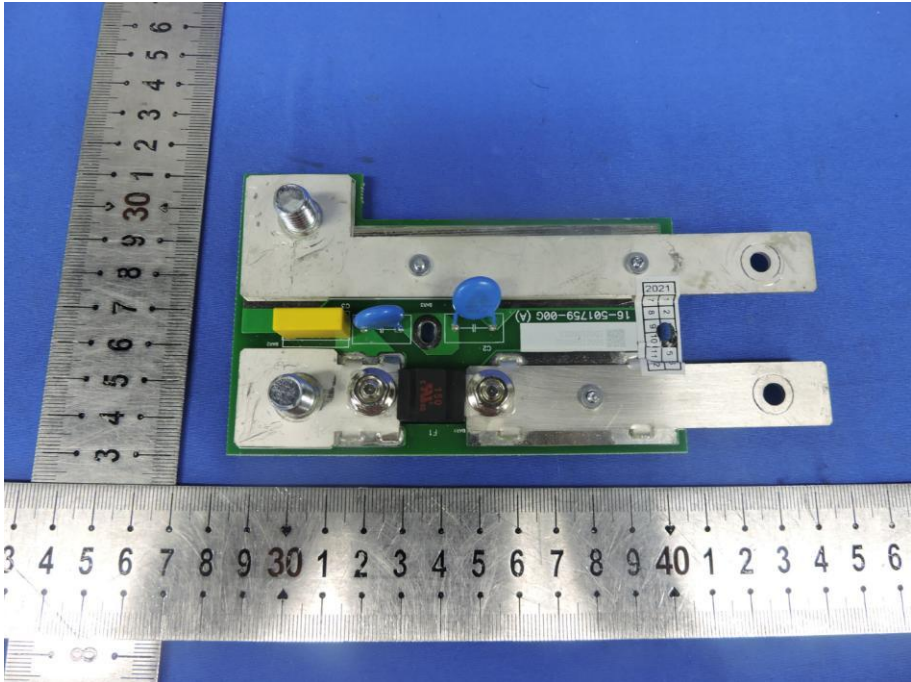

Fig. 23---PCB View

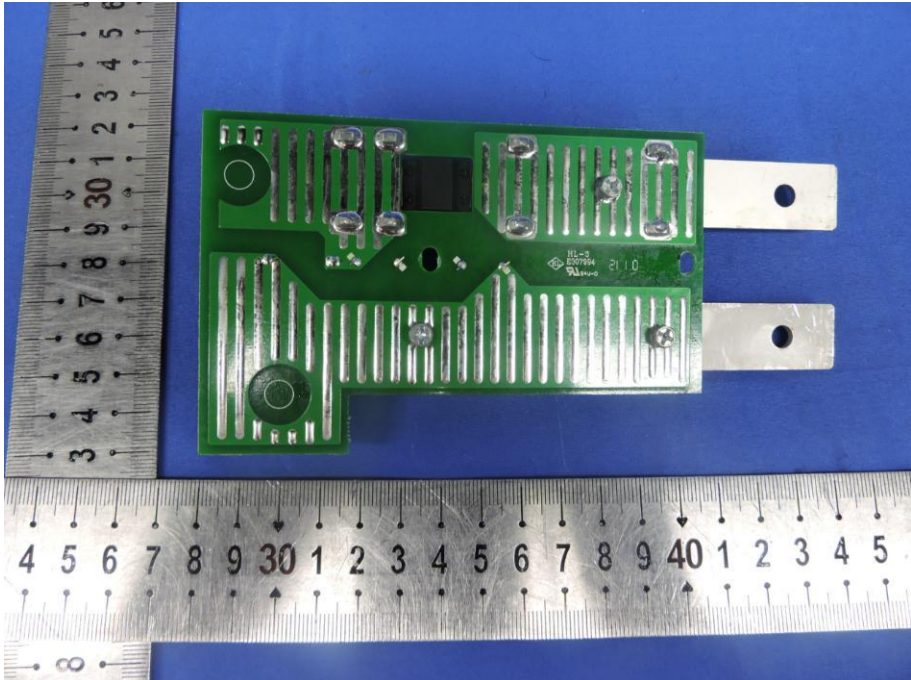

Fig. 24---PCB View

Photo Documentation

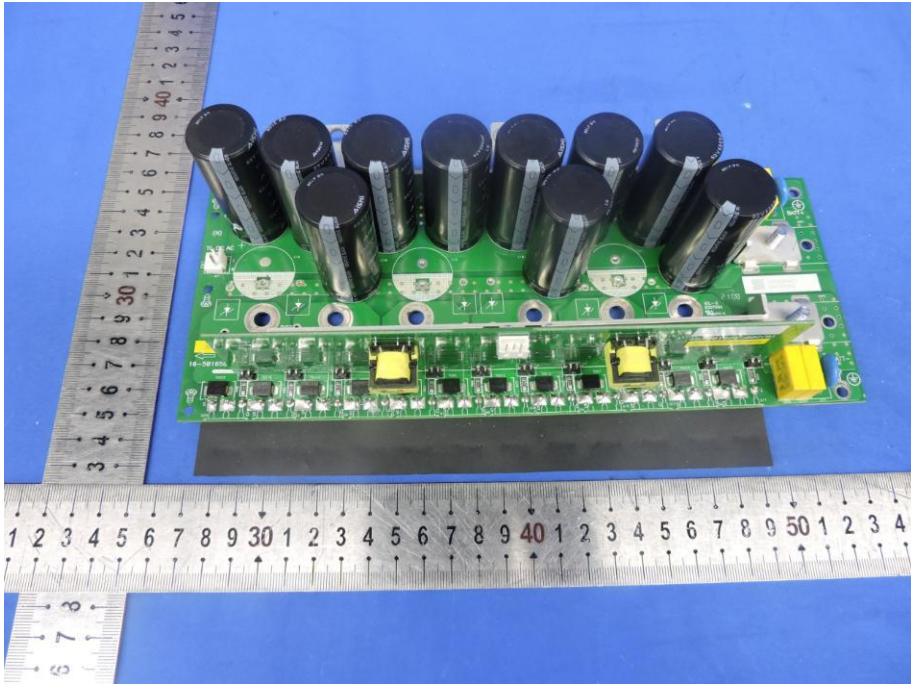

Fig. 25---PCB View

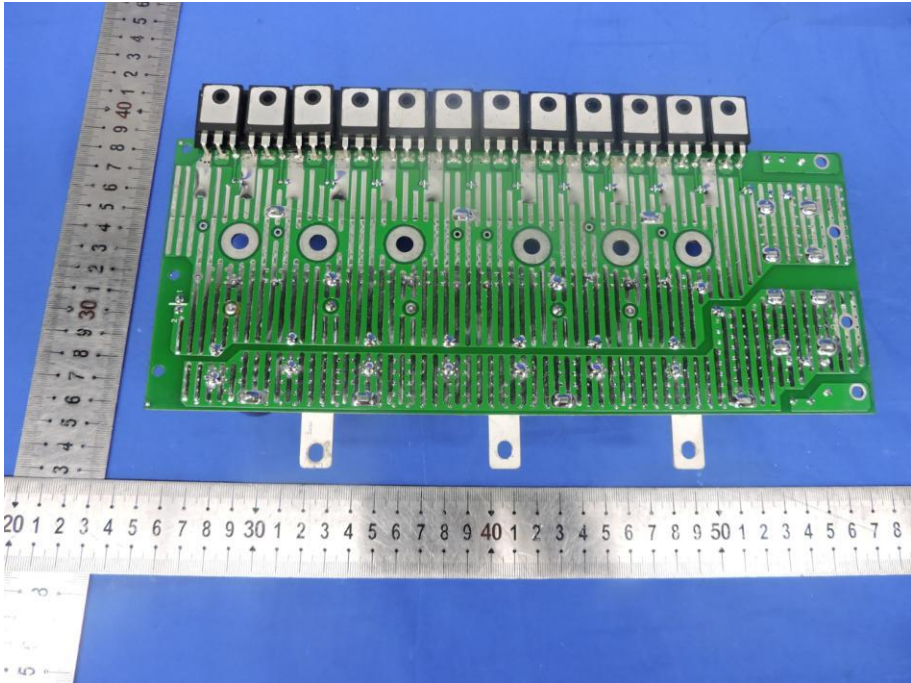

Fig. 26---PCB View

Photo Documentation

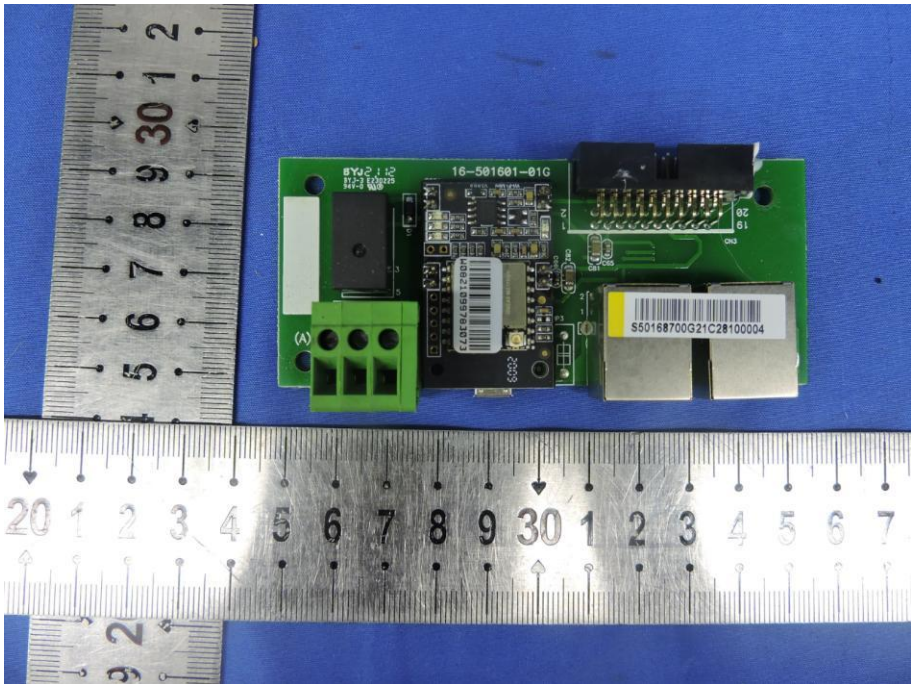

Fig. 27---PCB View

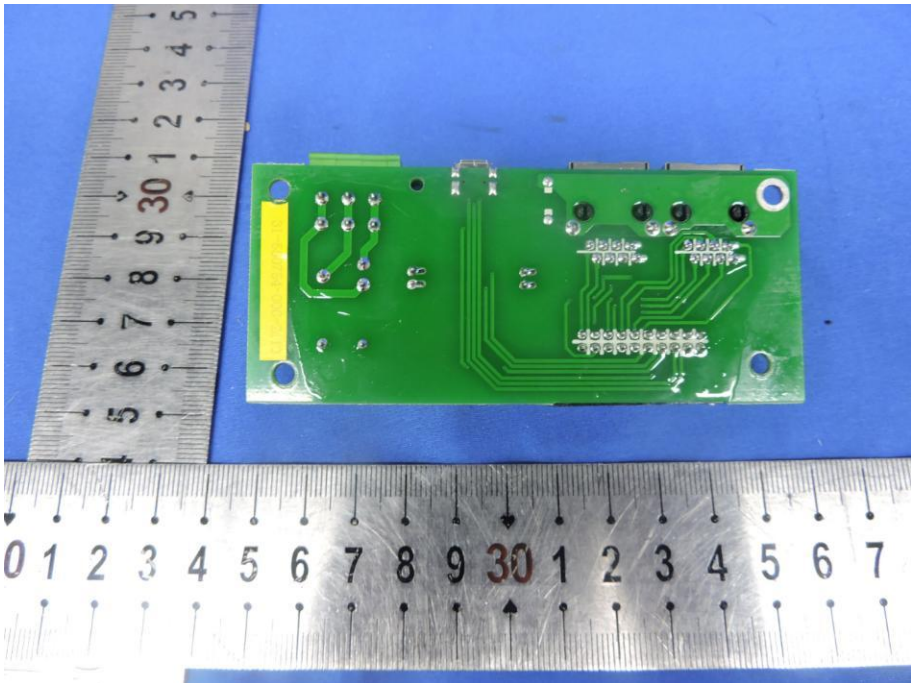

Fig. 28---PCB View

Photo Documentation

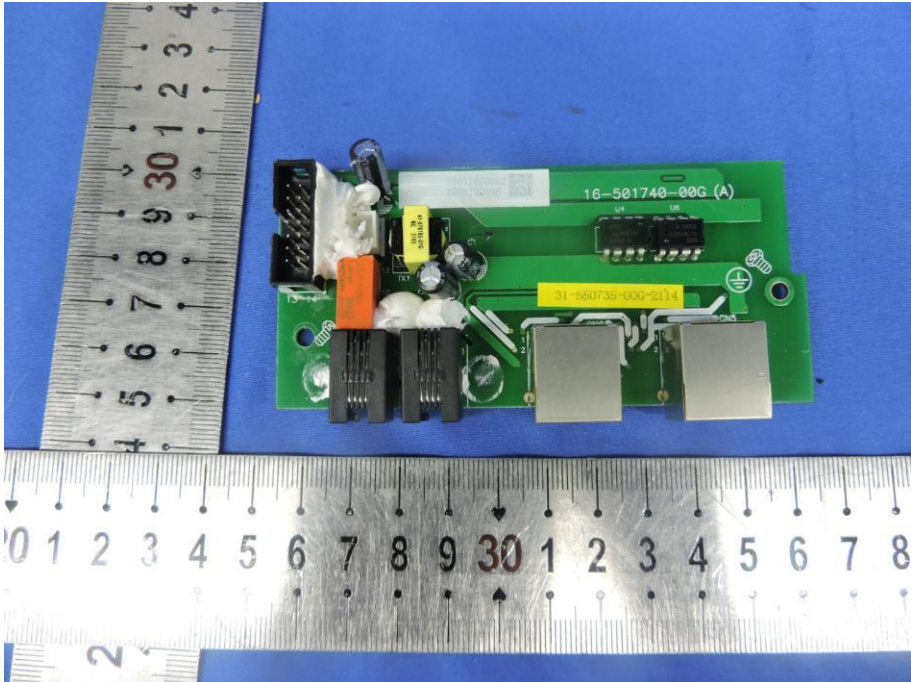

Fig. 29---PCB View

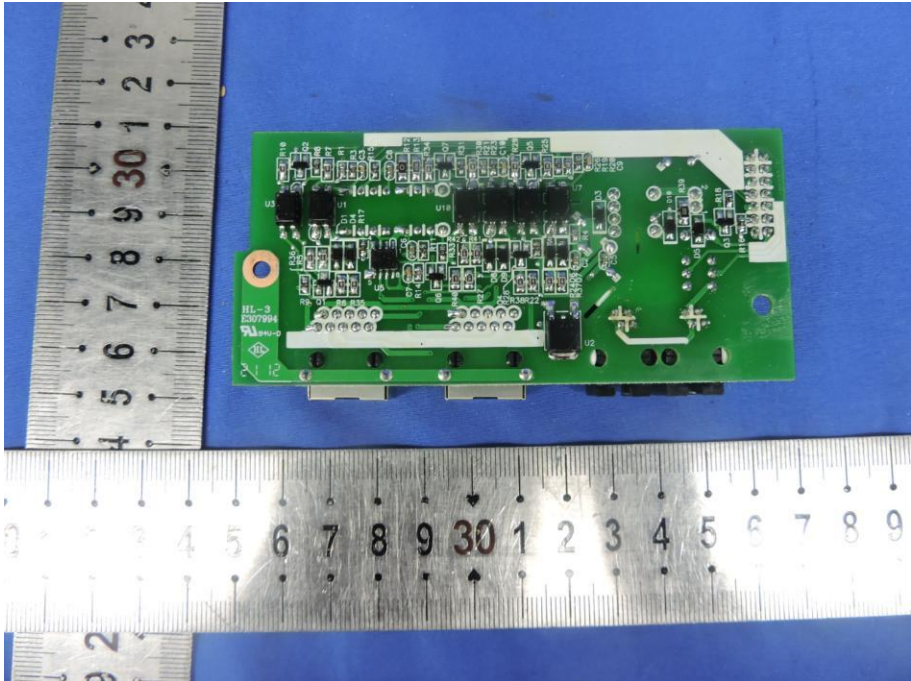

Fig. 30---PCB View

Photo Documentation

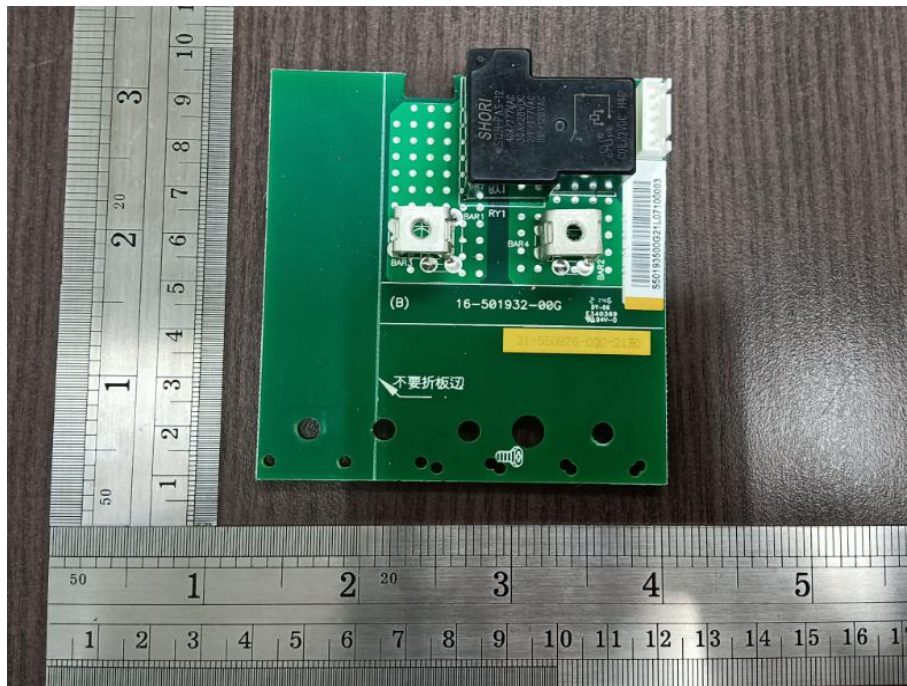

Fig. 31---PCB View

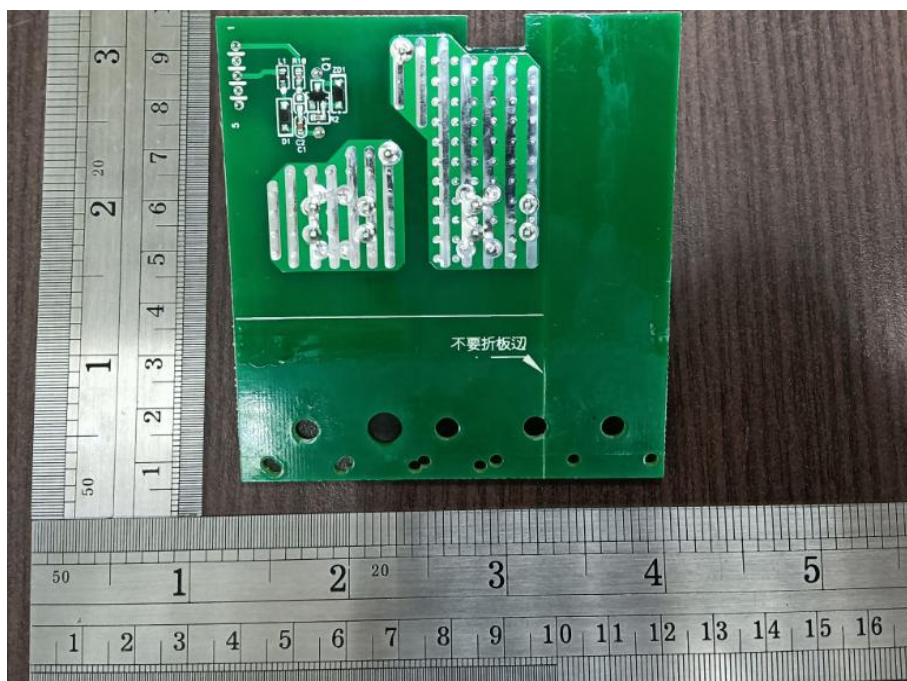

Fig. 32---PCB View

-----END OF THIS TEST REPORT-----